

LANG[®]

Desde 1928

CATÁLOGO GERAL DE INSTRUMENTAL CIRÚRGICO

Instrumental cirúrgico fabricado no Brasil
com tecnologia e matéria prima Alemã.







SIGMUND LANG

Na região de TUTTLINGEN, Alemanha, por alguns séculos, reside a origem dos artesões na arte de criar material cirúrgico.

Nascido na cidade de STETTEN, Sul da Alemanha, SIGMUND LANG chegou ao Brasil no ano de 1924 como imigrante, trazendo em sua bagagem apenas o ideal e a esperança de aqui, em terras brasileiras, ajudar a medicina e os médicos na busca da cura, objetivo final de tão nobilíssima profissão. Movido por tal ideal, em 1928, fundou na cidade do Rio de Janeiro a LANG.

Cada instrumento cirúrgico por ele criado foi fruto da sua predestinada inteligência, habilidade manual e arte. Sua sabedoria, ao longo do tempo e no trabalho diário, foi transmitida ao seu filho, netos e bisnetos, os quais hoje dão continuidade para a concretização daquele precursor ideal.

Este catálogo, que elenca o acervo da LANG, revela uma experiência de mais de oitenta e cinco anos no mercado vivida sempre ao lado dos mais renomados profissionais da medicina, circunstância que dá aos seus produtos confiabilidade e segurança, indispensáveis para o fim a que se destinam.



É fato notório que cerca de 80% de todo o instrumental cirúrgico circulante no mundo, é fabricado em aço inoxidável e certamente existe sob o ponto de vista comercial, uma série de aços inoxidáveis especiais, para as mais diversas aplicações.

Porém, tendo em mente as finalidades e características peculiares dos instrumentais cirúrgicos, esta grande série fica reduzida a apenas alguns poucos tipos, isso significa que para cada grupo de instrumentos existe um aço inoxidável recomendado pela norma DIN Alemã 17.442. Assim por exemplo, na fabricação de pinças hemostáticas, afastadores, espéculos, tesouras e outros materiais de corte, são utilizados diferentes tipos de aço inoxidável. A título informativo e tendo como referência as Normas Internacionais vigentes, transcrevemos na tabela abaixo a composição química média e percentual dos aços mais utilizados nesta fabricação.

Embora todos os tipos de aços inoxidáveis sejam bem adequados à finalidade de uso, isso não significa que, 'INOXIDÁVEL', seja uma palavra mágica, como inalterável ou indestrutível. Na realidade não existe uma composição química ideal que possa evitar todos os tipos de ataques, evitando manchas, falta de brilho, ou mesmo certas zonas de corrosão. E é por isso que se tem certos cuidados para que o instrumental não apresente essas manchas e até corrosão.

Assim como a matéria prima é fundamental para a fabricação do instrumental, a forma, o desenho, as medidas, devem respeitar determinadas tolerâncias que irão conferir aos produtos um elevado grau de qualidade. Nesses termos o instrumental deverá estar conforme a norma DIN 100 – Medizin I.

O instrumental cirúrgico deverá ter um tratamento térmico integral (em toda a peça) e homogêneo, o que irá garantir a flexibilidade e resistência à corrosão. Peças com tratamento térmico apenas nas pontas, estão fora das condições de aceitabilidade.

Assim sendo, AS PINÇAS que irão realizar a hemostasia, deverão na sua fabricação, ter as pontas delicadas, com bom acabamento, sem buracos, frestas ou folgas no encaixe. As cremalheiras deverão ter um funcionamento suave e progressivo, sem trancos e agarre. As pinças não deverão apresentar cantos vivos nas pontas ou encaixes que possam ferir pacientes ou cortar luvas. As pinças como Kocher ou Allis que possuem dentes, os mesmos não deverão ser pontiagudos ou cortantes. As pinças com acabamento atraumático, como os clamps >>

Composição Química Percentual

Tipo de Aço/Padrão AISI	Carbono (Ca)	Cromo (Cr)	Níquel (NI)	Molibdênio (Mo)
304	0,08 máx	18,0-20,0	8,0-12,0	-
316	0,08 máx	16,0-18,0	10,0-14,0	2,0-3,0
410	0,15 máx	11,5-13,5	-	-
420	0,15 máx	12,0-14,0	-	-
440 A	0,60-075	16,0-18,0	-	0,75 máx

intestinais e cardiovasculares, deverão ter no seu acabamento dentes ou serrilhas que não produzam ferimentos ou tramas nos tecidos que iram prender ou “clampar”.

AS PINÇAS DE DISSECÇÃO que são fabricadas com serrilhas, deverão ser delicadas com bom acabamento, de modo a evitar cantos vivos cortantes, as que possuem dentes de rato deverão ter encaixe perfeitos entre os dentes.

OS PORTA AGULHAS deverão ter suas serrilhas com acabamento perfeito, permitindo encaixe preciso para que a agulha não rode. O rasgo para acomodação da agulha deverá ter as dimensões recomendadas pela norma DIN 100. As cremalheiras deverão ter um funcionamento suave e progressivo, sem trancos e agarre.

AS TESOURAS deverão ter um tratamento térmico adequado de modo que a dureza alcançada seja suficiente para atender às finalidades de uso da mesma. Deverão estar bem reguladas a fim de que a peça corte muito bem e ao mesmo tempo não se desgaste excessivamente em função do roçamento de uma lâmina contra outra. As pontas deverão ser delicadas e adequadas ao trabalho a que se destinam. Favor conferir no capítulo “manutenção das tesouras”.

Como qualquer outro material utilizado pela Engenharia, os aços inoxidáveis também apresentam aspectos de fragilidade e limitação, que vão desde fenômenos de corrosão, e fadiga mecânica até a formação de manchas superficiais diversas.

Foi pensando nestas possibilidades, que tentaremos estabelecer abaixo as melhores condutas, objetivando maximizar a vida útil e funcional do instrumento cirúrgico. Por isto, é muito importante seguir sempre estas recomendações, para cada diferente etapa:

I. Limpeza Prévia ou Desincrustação:

É a remoção da matéria orgânica do instrumental, sem o contato manual direto. Deve iniciar-se o mais rapidamente possível.

Recomendações:

1. O responsável pela tarefa deverá estar paramentado, com os artigos de proteção individual, (luvas, máscaras, óculos, aventais, gorros, etc.);

2. Utilizar solução enzimática, em concentração e exposição de tempo, conforme determinação do fabricante destas soluções químicas;

3. Realizar um enxágüe único, diretamente em jato de água, sem manusear os instrumentos cirúrgicos;

II. Descontaminação:

É a eliminação de microrganismos na forma vegetativa, que oferecem riscos ocupacionais.

Recomendações:

1. O responsável pela tarefa deve estar paramentado, com os artigos de proteção individual mencionado acima;

2. Utilizar solução a base de fenol ou de amônia, em concentração e exposição de tempo, conforme determinação do fabricante destas soluções químicas;

3. Realizar um enxágüe único, diretamente em jato de água, sem o manuseio dos instrumentos cirúrgicos.

III. Lavagem:

É a remoção mecânica das sujidades dos instrumentos cirúrgicos, através de escovação manual ou vibrações produzidas por ultra-som.

Recomendações:

1. Utilizar sempre para este procedimento, água destilada, deionizada, ou desmineralizada. Se a água estiver aquecida, para facilitar a limpeza, esta temperatura deverá estar entre 40°C e 50°C ;

2. Utilizar sabão neutro a 1% ou detergente neutro, ambos com pH7,0;

3. Utilizar sempre escovas com cerdas macias naturais ou de nylon para a limpeza de cremalheiras, serrilhas e encaixes;

4. Nunca utilizar palhas ou esponjas de aço e produtos abrasivos, para que não danifiquem os instrumentais em uso;

5. Não acumular os instrumentais em grandes quantidades, uns sobre os outros, para impedir a deformação de peças menores e delicadas. Manusear sempre poucas peças por vez;

6. Os instrumentos maiores, tipo afastadores e os instrumentais multicomponentes, devem ser desmontados e tratados separadamente.

7. A limpeza por ultra-som, se utilizada, deve ter a solução para lavagem aquecida a pelo menos 45°C, e os instrumentos devem ser colocados na posição aberta. De 3 a 5 minutos de imersão, em uma frequência de 35 kilohertz, é o suficiente para a limpeza dos instrumentos. A necessidade de escovamento de partes serrilhadas de articulações, contudo, pode ainda ser necessária.

IV. Enxague:

É a remoção de resíduos químicos, detergentes e espuma ainda presentes.

Recomendações:

1. Utilizar sempre para o enxágüe, água destilada, deionizada, ou desmineralizada. Se a água estiver aquecida, sua temperatura deverá estar entre 40°C a 45°C;

2. Nunca utilizar soluções salinas, principalmente hipoclorito de sódio e soro fisiológico, desinfetantes, água oxigenada, ou álcool para limpeza ou enxágüe dos instrumentais cirúrgicos.

V. Secagem:

É a retirada de água residual e umidade, após procedimento de enxágüe.

Recomendação:

1. Nunca deixar o instrumento secar de "forma natural". Utilizar sempre tecido macio e absorvente (por exemplo, compressas) ou ar comprimido isento de umidade.

VI. Revisão e Inspeção:

É o ato de verificar se o instrumental não apresenta qualquer irregularidade, deformidade, ou resíduo de sujidade.

Recomendação:

1. Todos os instrumentos deteriorados, ou que apresentem indícios de corrosão, devem ser separados, para evitar que o processo de corrosão se alastre por contatos aos demais instrumentais;

2. Proteger sempre a ponta dos instrumentos mais delicados;

3. Nunca armazenar instrumentos limpos, em caixas cirúrgicas manchadas ou com riscos severos, que possam ser focos de contaminação para o instrumental. Separar os materiais pesados, dos delicados e de pouco peso.

VII. Lubrificação:

É o cuidado, que vai permitir que as articulações dos instrumentais cirúrgicos, permaneçam maleáveis durante o uso.

Recomendação:

Utilizar sempre lubrificante hidrossolúvel, de acordo com a farmacopéia Internacional, principalmente nas articulações de afastadores, pinças hemostáticas, tesouras e porta-agulhas.

VIII. Esterilização:

É o procedimento que visa à eliminação total dos microorganismos (vírus, bactérias, micróbios e fungos), seja na forma vegetativa ou esporulada.

a) Esterilização pelo vapor saturado sob pressão – Autoclave

Recomendação:

1. Utilizar para a autoclave, água destilada, desmineralizada ou deionizada, para que o vapor resultante esteja isento de impurezas. Ainda assim se necessário, a autoclave deverá possuir filtros adequados para reter impurezas;

2. Os instrumentais cirúrgicos devem ser dispostos abertos, principalmente as pinças hemostáticas e porta-agulhas, ou no máximo fechados apenas no primeiro dente da cremalheira, em bandejas e as mesmas envolvidas em campo duplo de algodão cru, ou colocadas em caixas "tipo container", perfuradas, apropriadas para este tipo esterilização;

3. Não abrir prematuramente a autoclave, para evitar a rápida condensação;

4. Não abrir a autoclave rapidamente, deixando todo o vapor sair primeiro e que o ciclo de secagem se complete;

5. Em uma autoclave convencional, o instrumental deverá ficar durante 30 minutos a uma temperatura de 121°C, quando esta temperatura for atingida. Numa autoclave de autovácuo, esse tempo deverá ser de 4 minutos a 132°C, quando essa temperatura for alcançada;

6. (Limpar rigorosamente e periodicamente a autoclave, removendo sujeiras e eventual excesso de ferrugem óxido de ferro).

b) Esterilização pelo calor seco – Estufa

Recomendação:

1. Verificar se o instrumental cirúrgico pode ser realmente esterilizado pelo calor seco e altas temperaturas. Utilizar estufa, em princípio, para instrumentos cortantes;

2. Colocar os instrumentos em caixas metálicas fechadas, como fundo forrado em papel alumínio, a fim de permitir uma melhor irradiação de calor para o seu interior;

3. Deixar os instrumentais cirúrgicos por 120 minutos a uma temperatura de 180°C, quando esta temperatura for alcançada e não deixar sob hipótese alguma que a mesma seja ultrapassada;

4. Revisar periodicamente o funcionamento da estufa, principalmente no tocante ao controle preciso de temperatura.

Observação:

Peças superficialmente cromadas, não podem ser esterilizadas a quente, e muito menos acompanhadas de peças em aço inoxidável. Este tipo de instrumental cirúrgico deve ser esterilizado via óxido de etileno.

Manchas Superficiais: São via de regra, alterações superficiais as superfície metálica e não se constituem de imediato em um processo de corrosão.

Tipo 1: Auréolas e manchas coloridas, parecendo as cores do arco-íris e sem contornos definidos.

Causas: São auréolas e manchas de água, provenientes de íons de metais pesados ou devidos a alta concentração de substâncias minerais ou orgânicas presentes na água.

Solução: São removidas mecanicamente, esfregando-as com escovas ou utilizando-se de limpador de aço inoxidável específico e adequado.

Tipo 2: resíduos amarelos ou marrom-escuro, presentes nos lugares difíceis de serem limpos. Não devem ser confundidos com oxidação (ferrugem).

Causas: Pode ser devido a resíduos protéticos incrustados, uso repetido de detergente que se agrega ao instrumental ou resíduo de soluções químicas desinfetantes não renovadas.

Solução: Limpar constantemente as cubas ou cestos de lavagem e descontaminação. Os resíduos desaparecem quando esfregados ou limpos com agentes de limpeza neutros, e se não eliminados, após certo tempo, certamente podem produzir corrosão e conseqüentemente deterioração do instrumento.

Tipo 3: Composição amarelada, por todo o instrumento.

Causas: Superaquecimento no processo de esterilização.

Solução: Verificar cuidadosamente o funcionamento do aparato de esterilização, principalmente no quesito de controle e aferição de temperaturas.

Tipo 4: Manchas cinza-azuladas.

Causa: Utilização a frio, de certas substâncias degermantes.

Solução: A solução química degermante deverá ser descartada frequentemente, com a análise rígida do tempo recomendado pelo fabricante. Como última medida, poderá se substituída por outro sistema de esterilização

Como entendemos o desgaste natural e as possíveis falhas de fabricação, aplicamos a nossa Garantia da seguinte forma:

- 1** Durante o primeiro ano de aquisição da peça, consideramos como defeitos de fabricação prováveis polimentos, ajustes, afiação de cortes, mal funcionamento e quebras prematuras, desde que utilizadas de forma correta e decorrentes do uso normal do produto;
- 2** Até o terceiro ano de utilização, consideramos como desgaste natural a necessidade de polimentos, ajustes e afiação de cortes, porém quebras neste período não são mais consideradas prematuras, mas poderão ser reparadas, após análise técnica;
- 3** Com a utilização da peça por 10 anos, faremos uma análise laboratorial e posterior laudo técnico contra corrosão e defeitos no aço inox, apontando os defeitos, podendo ser realizado conserto ou mesmo a troca da peça,

IMPORTANTE

É preciso entender que o material desgasta-se com o passar do tempo, constantes processos químicos de limpeza, autoclavagem e uso freqüente, sendo assim não é possível oferecer 10 anos de garantia para determinados tipos de manutenção.

A cópia do presente **CATÁLOGO DE INSTRUMENTAL CIRÚRGICO LANG** deve ser usado pelo comércio especializado e autorizado, exclusivamente para a compra e venda dos produtos **LANG** prescrito por utilizadores institucionais e particulares, para cobrir as suas necessidades com os produtos **LANG**.

No caso deste catálogo estar sendo utilizado contra nossos interesses, estamos autorizados a reivindicá-lo de volta incondicionalmente, reservado o direito de eventuais medidas.

Neste catálogo tentamos reproduzir as ilustrações e medições para corresponder o melhor possível com o produto original. As medidas podem, no entanto, não se aproximarem devido os instrumentos serem feitos de forma artesanais, todavia, não afeta a função do mesmo.

Também nos reservamos do direito de modificar a forma e o tamanho dos nossos instrumentais, sempre que os métodos de fabricação e técnicas forem melhoradas.

É proibido reproduzir ou copiar este catalogo no todo ou em parte sem a nossa autorização por escrito.

TODAS AS IMAGENS NESTE CATALOGO SÃO MERAMENTE ILUSTRATIVAS, NÃO SIGNIFICANDO QUE O INSTRUMENTO REPRESENTA EXATAMENTE O TAMANHO OU FORMA COMPARADO COM A ILUSTRAÇÃO.

© Copyright 2009. Lang e Filhos Material Hospitalar Ltda./ME. Todos os direitos reservados.

1º Edição
Ano 2014

10

Cabos de bisturi

15

Tentacanal
Estiletos
Clips

35

Neurocirurgia

11

Tesouras

16

Agulhas e
Aspiradores

40

Dermatologia

12

Pinças Dissecção

17

Porta Agulhas

45

Ginecologia

13

Pinças Hemostáticas

20

Ortopedia
Cirurgia Óssea

48

Proctologia

14

Afastadores
Ganchos
Espátulas
Valvas

30

Cardiovascular

49

Urologia

50

Ouvido

62

Microcirurgia

51

Nariz

52

Garganta

55

Bucomaxilo

60

Plástica

10

SÃO UTILIZADOS COMO SUPORTE PARA AS
LÂMINAS QUE VÃO INCISIONAR OS TECIDOS.



N° 3
16 CM - 10-020-16
20 CM - 10-020-20
24 CM - 10-020-24



N° 4
16 CM - 10-032-16
20 CM - 10-032-20
24 CM - 10-032-24



N° 3
16 CM - 10-021-16
20 CM - 10-021-20
24 CM - 10-021-24



N° 4
16 CM - 10-033-16
20 CM - 10-033-20
24 CM - 10-033-24



No 3
10-018-03



No 4
10-018-04



No. 7
10-018-07



No. 3L
10-018-03L



No. 4L
10-018-04L

11

Manutenção de Tesouras

As tesouras na sua fabricação deverão ter um tratamento térmico adequado de modo que a dureza alcançada seja suficiente para atender às finalidades de uso da mesma. Deverão estar reguladas a fim de que a peça corte muito bem e ao mesmo tempo não se desgaste excessivamente em função do roçamento de uma lâmina contra a outra. As pontas deverão ser delicadas e adequadas ao trabalho a que se destinam. O peso deverá ser o menor possível e o polimento deverá ser isentos de buracos ou defeitos superficiais que possam provocar manchas ou corrosão.

Um problema muito comum nos Hospitais é com relação a vida útil das tesouras cirúrgicas, que por serem utilizadas várias vezes ao dia em diversos procedimentos cirúrgicos, passam por processos constante de desinfecção química e autoclavagem, a consequência desta utilização é a perda do fio e na maioria das vezes elas são entregues a pessoas sem capacitação técnica que não têm a devida percepção, para avaliar o problema, e acabam afiando a tesoura de forma errada e as vezes desnecessariamente. O pior é que afiam muito mal, "esmerilhando e arrancando material", descaracterizando a tesoura, destruindo a camada de têmpera feita pela fábrica. Isso é muito fácil de notar, quando se olha uma tesoura e verifica que uma lâmina não se sobrepõe normalmente a outra.

Sugerimos que as tesouras LANG devem ser revisadas no mínimo uma vez por ano, dessa forma, a sua vida útil poderá ser da ordem de 6 a 8 anos, sempre que forem tomados todos os cuidados necessários no dia-a-dia para a sua conservação.

IMPORTANTE: Após a lavagem e secagem das tesouras e antes de montar as caixas cirúrgicas, as peças deverão passar por um rígido controle de qualidade, as que estiverem com articulações endurecidas, vestígios de corrosão, oxidação ou ferrugem, pontas desalinhadas, cortes imperfeitos, deverão ser colocadas de lado e substituídas imediatamente e não deverão fazer parte de uma caixa bem preparada. Com relação as tesouras, sugerimos proteger a ponta com gases, a fim de se evitar quebra por batidas ou quedas. Em procedimentos como os cardiovasculares, ortopédicos, neurocirúrgicos, ginecológicos e cirurgia geral, sugerimos a aquisição de tesouras da linha Special Line LANG e Tesouras com widea LANG que oferecem melhor precisão no corte além de serem muito mais duráveis.

Tesouras

As tesouras têm diversas funções para cada tarefa e especialidade médico cirúrgica, porém deverão estar bem reguladas a fim de que a peça corte muito bem e ao mesmo tempo não se desgaste excessivamente em função do roçamento de uma lâmina contra outra.



Tesoura Special Line: Fabricada com uma lâmina serrilhada reforçada para suportar a pressão de cirurgias sucessivas, oferecendo precisão no corte. O cabo preto a distingue das tesouras com widea e comuns.

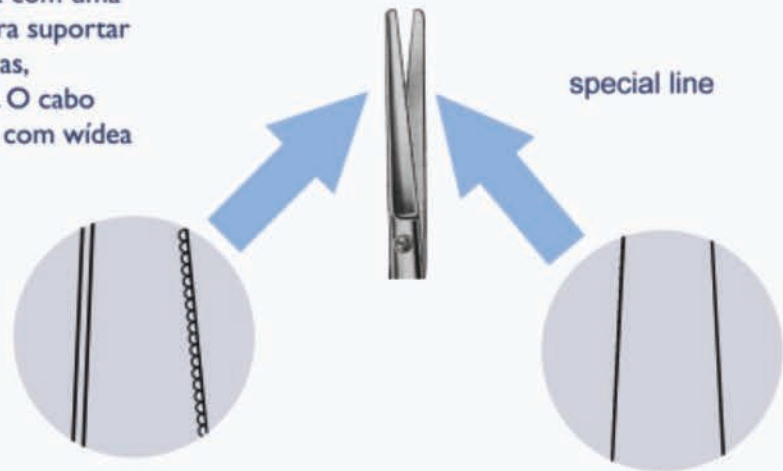

Tesoura com widea: tratamento realizado na têmpera da lâmina, aumentando sua durabilidade e precisão no corte. Seu cabo dourado a distingue dos outros modelos.

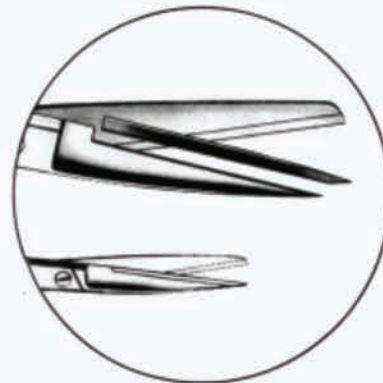



15 CM - 11-065-15
17 CM - 11-065-17

WÍDEA
15 CM - 11-065-15W
17 CM - 11-065-17W

TESOURA
CIRÚRGICA
R X R



15 CM - 11-055-15
17 CM - 11-055-17

WÍDEA
15 CM - 11-055-15W
17 CM - 11-055-17W

TESOURA
CIRÚRGICA
F X F



15 CM - 11-061-15
17 CM - 11-061-17

WÍDEA
15 CM - 11-061-15W
17 CM - 11-061-17W

TESOURA
CIRÚRGICA
F X R



15 CM - 11-064-15
17 CM - 11-064-17

WÍDEA
15 CM - 11-064-15W
17 CM - 11-064-17W

TESOURA
CIRÚRGICA CURVA
R X R



15 CM - 11-054-15
17 CM - 11-054-17

WÍDEA
15 CM - 11-054-15W
17 CM - 11-054-17W

TESOURA
CIRÚRGICA CURVA
F X F



15 CM - 11-060-15
17 CM - 11-060-17

WÍDEA
15 CM - 11-060-15W
17 CM - 11-060-17W

TESOURA
CIRÚRGICA CURVA
F X R



DIETRICH 18 CM



25°
11-420-25

WÍDEA
11-420-25W



45°
11-420-45
14 CM - 11-422-45

WÍDEA
11-420-45W
14 CM - 11-422-45W



60°
11-420-60
14 CM - 11-422-60

WÍDEA
11-420-60W
14 CM - 11-422-60W



90°
11-420-90

WÍDEA
11-420-90W



125°
11-420-12



12 CM - 11-096-12
14 CM - 11-096-14

SPECIAL LINE
14 CM - 11-096-14SSL

FOMON



18 CM - 11-102-18S

FOMON ACOTOVELADA
SERRILHADA



18 CM - 35-345-18

FRAZIER



SERRILHADA
18 CM - 11-132-18S

HEYMANN
ANGULADA C/ SERRILHA



IRIS RETA

PONTA FINA
12 CM - 11-151-12

PONTA ROMBA
12 CM - 11-153-12

SPECIAL LINE
PONTA FINA
12 CM - 11-151-12SSL

PONTA ROMBA
12 CM - 11-153-12SSL

WÍDEA
PONTA FINA
12 CM - 11-151-12W

PONTA ROMBA
12 CM - 11-153-12W



IRIS CURVA

PONTA FINA
12 CM - 11-150-12

PONTA ROMBA
12 CM - 11-152-12S

SPECIAL LINE
PONTA FINA
12 CM - 11-150-12SSL

PONTA ROMBA
12 CM - 11-152-12SSL

WÍDEA
PONTA FINA
12 CM - 11-150-12W

PONTA ROMBA
12 CM - 11-152-12W



JOSEPH RETA

14 CM - 11-163-14
18 CM - 11-163-18

SERRILHADA
14 CM - 11-163-14S
18 CM - 11-163-18S

SPECIAL LINE
14 CM - 11-163-14SSL
18 CM - 11-163-18SSL

PTA ROMBA
14 CM - 11-165-14
18 CM - 11-165-18

WÍDEA
14 CM - 11-163-14W
18 CM - 11-163-18W

PTA ROMBA
14 CM - 11-165-14W
18 CM - 11-165-18W



JOSEPH CURVA

14 CM - 11-162-14
18 CM - 11-162-18

SERRILHADA
14 CM - 11-162-14S
18 CM - 11-162-18S

SPECIAL LINE
14 CM - 11-162-14SSL
18 CM - 11-162-18SSL

PTA ROMBA
14 CM - 11-164-14
18 CM - 11-164-18

WÍDEA
14 CM - 11-162-14W
18 CM - 11-162-18W

PTA ROMBA
14 CM - 11-164-14W
18 CM - 11-164-18W

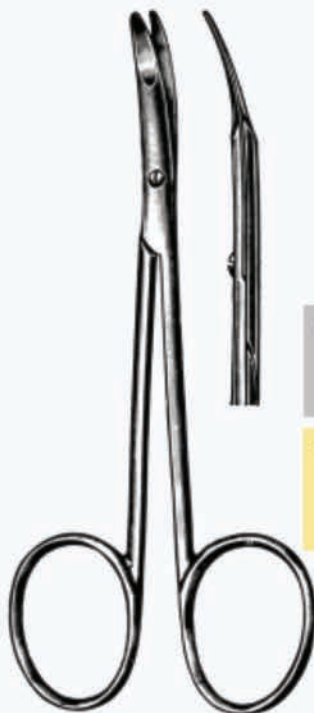

KILNER CURVA

12 CM - 11-180-12
14 CM - 11-180-14

SPECIAL LINE
12 CM - 11-180-12SSL
14 CM - 11-180-14SSL

WÍDEA
12 CM - 11-180-12W
14 CM - 11-180-14W

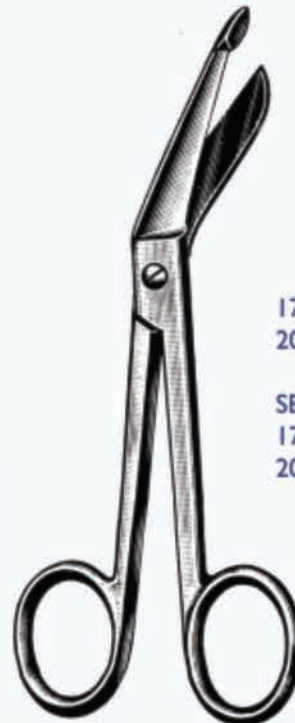

LISTER

17 CM - 11-192-17
20 CM - 11-192-20

SERRILHADA
17 CM - 11-192-17S
20 CM - 11-192-20S



20 CM - 11-205-20
23 CM - 11-205-23

WIDEA
20 CM - 11-205-20W
23 CM - 11-205-23W

**MAYO
HARRINGTON RETA**



20 CM - 11-205-20
23 CM - 11-204-23

WIDEA
20 CM - 11-205-20W
23 CM - 11-204-23W

**MAYO
HARRINGTON CURVA**



SERRILHADA
18 CM - 11-241-18S

SPECIAL LINE
18 CM - 11-241-18SSL

WIDEA
18 CM - 11-241-18W

MC INDOE



15 CM - 11-229-15
17 CM - 11-229-17
19 CM - 11-229-19

SPECIAL LINE
15 CM - 11-229-15SSL
17 CM - 11-229-17SSL
19 CM - 11-229-19SSL

WIDEA
15 CM - 11-229-15W
17 CM - 11-229-17W
19 CM - 11-229-19W

MAYO STILLE RETA



15 CM - 11-228-15
17 CM - 11-228-17
19 CM - 11-228-19

SPECIAL LINE
15 CM - 11-228-15SSL
17 CM - 11-228-17SSL
19 CM - 11-228-19SSL

WIDEA
15 CM - 11-228-15W
17 CM - 11-228-17W
19 CM - 11-228-19W

MAYO STILLE CURVA



METZENBAUM RETA

12 CM - 11-301-12
 14 CM - 11-301-14
 18 CM - 11-301-18
 20 CM - 11-301-20
 23 CM - 11-301-23
 25 CM - 11-301-25
 30 CM - 11-301-30

SPECIAL LINE

12 CM - 11-301-12SSL
 14 CM - 11-301-14SSL
 18 CM - 11-301-18SSL
 20 CM - 11-301-20SSL
 23 CM - 11-301-23SSL
 25 CM - 11-301-25SSL
 30 CM - 11-301-30SSL

REVESTIDO

20 CM - 70-301-20R

WÍDEA

12 CM - 11-301-12W
 14 CM - 11-301-14W
 18 CM - 11-301-18W
 20 CM - 11-301-20W
 23 CM - 11-301-23W
 25 CM - 11-301-25W
 30 CM - 11-301-30W



METZENBAUM CURVA

12 CM - 11-300-12
 14 CM - 11-300-14
 18 CM - 11-300-18
 20 CM - 11-300-20
 23 CM - 11-300-23
 25 CM - 11-300-25
 30 CM - 11-300-30

SPECIAL LINE

12 CM - 11-300-12SSL
 14 CM - 11-300-14SSL
 18 CM - 11-300-18SSL
 20 CM - 11-300-20SSL
 23 CM - 11-300-23SSL
 25 CM - 11-300-25SSL
 30 CM - 11-300-30SSL

REVESTIDO

20 CM - 70-300-20R

WÍDEA

12 CM - 11-300-12W
 14 CM - 11-300-14W
 18 CM - 11-300-18W
 20 CM - 11-300-20W
 23 CM - 11-300-23W
 25 CM - 11-300-25W
 30 CM - 11-300-30W



METZENBAUM VASCULAR RETA

12 CM - 11-307-12
 14 CM - 11-307-14
 18 CM - 11-307-18
 20 CM - 11-307-20
 23 CM - 11-307-23
 25 CM - 11-307-25

WÍDEA

12 CM - 11-307-12W
 14 CM - 11-307-14W
 18 CM - 11-307-18W
 20 CM - 11-307-20W
 23 CM - 11-307-23W
 25 CM - 11-307-25W



METZENBAUM VASCULAR CURVA

12 CM - 11-306-12
 14 CM - 11-306-14
 18 CM - 11-306-18
 20 CM - 11-306-20
 23 CM - 11-306-23
 25 CM - 11-306-25

WÍDEA

12 CM - 11-306-12W
 14 CM - 11-306-14W
 18 CM - 11-306-18W
 20 CM - 11-306-20W
 23 CM - 11-306-23W
 25 CM - 11-306-25W



13 CM - 51-600-13



OLIVECRONA

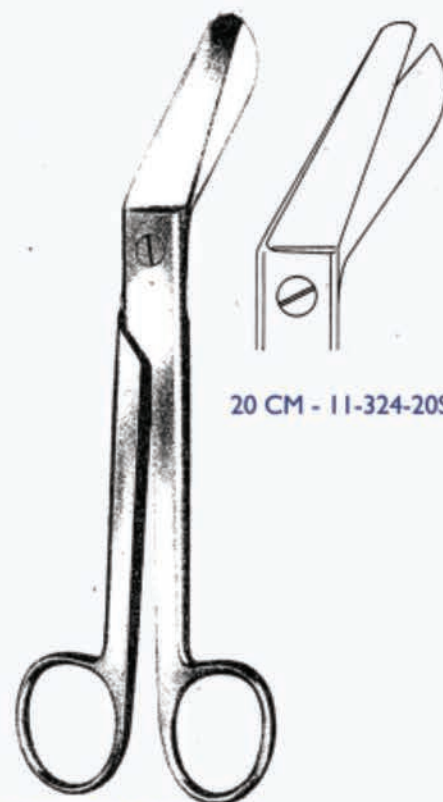

20 CM - 11-324-20S

TESOURA P/CORTAR
TUBOS SERRILHADA

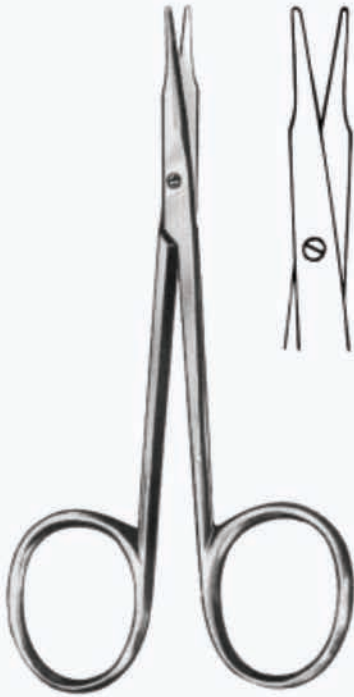

STEVENS PONTA ROMBA

RETA
11 CM - 11-543-11

WÍDEA
11 CM - 11-543-11W

CURVA
11 CM - 11-542-11

SPECIAL LINE
11 CM - 11-542-11SSL

WÍDEA
11 CM - 11-542-11W



STEVENS PONTA FINA

RETA
11 CM - 11-541-11

WÍDEA
11 CM - 11-541-11W

CURVA
11 CM - 11-540-11

SPECIAL LINE
11 CM - 11-540-11SSL

WÍDEA
11 CM - 11-540-11W



STRULLY

CURVA
18 CM - 35-350-18
20 CM - 35-350-20
22 CM - 35-350-22

RETA
20 CM - 35-351-20



TESOURA UNIVERSAL P/ FIO DE AÇO

12 CM - 11-831-12

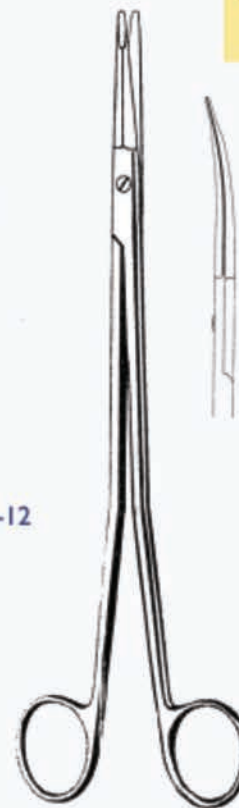

GORNEY

SERRILHADA
17 CM - 11-120-17S
20 CM - 11-120-20S
25 CM - 11-120-25S

SPECIAL LINE
17 CM - 11-120-17SSL
20 CM - 11-120-20SSL
25 CM - 11-120-25SSL

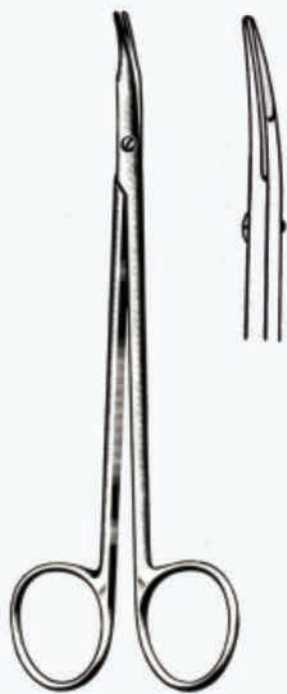

REYNOLD CURVA

14 CM - 11-468-14
18 CM - 11-468-18

SERRILHADA
14 CM - 11-468-14S

SPECIAL LINE
14 CM - 11-468-14SSL

WÍDEA
14 CM - 11-468-14W



REYNOLD RETA

14 CM - 11-469-14
18 CM - 11-469-18

SERRILHADA
14 CM - 11-469-14S

SPECIAL LINE
14 CM - 11-469-14SSL

WÍDEA
14 CM - 11-469-14W



20 CM - 11-491-20

WÍDEA
20 CM - 11-491-20W

SIMS RETA



09 CM - 11-515-09
12 CM - 11-515-12

WÍDIA
12 CM - 11-515-12W

SPENCER RETA

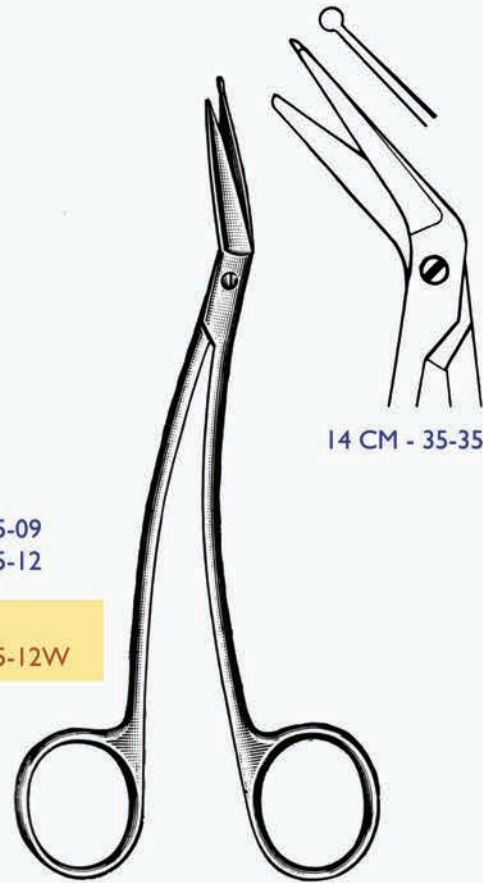

14 CM - 35-354-14

TAYLOR



ASTON

RETA
17 CM - 11-005-17
19 CM - 11-005-19

WÍDIA
17 CM - 11-005-17W
19 CM - 11-005-19W

CURVA SERRILHADA
17 CM - 11-006-17S
19 CM - 11-006-19S

WÍDIA
17 CM - 11-006-17W
19 CM - 11-006-19W



BARRAQUER



14 CM - 11-012-14
16 CM - 11-012-16



14 CM - 11-013-14
16 CM - 11-013-16



CASTROVIEJO



14 CM - 11-049-14
16 CM - 11-049-16
18 CM - 11-049-18



09 CM - 11-048-09
14 CM - 11-048-14
16 CM - 11-048-16
18 CM - 11-048-18



45°
14 CM - 11-045-14
16 CM - 11-045-16
18 CM - 11-045-18



60°
18 CM - 11-060-18

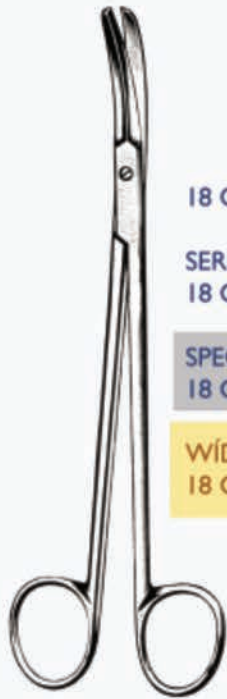

18 CM - 11-024-18

SERRILHADA
18 CM - 11-024-18S

SPECIAL LINE
18 CM - 11-024-18SSL

WÍDEA
18 CM - 11-024-18W

BOETTCHER



14 CM - 11-036-14
18 CM - 11-036-18
20 CM - 11-036-20

WÍDIA
14 CM - 11-036-14W
18 CM - 11-036-18W
20 CM - 11-036-20W

BOYD CURVA EM S



14 CM - 11-038-14
18 CM - 11-038-18
20 CM - 11-038-20

WÍDIA
14 CM - 11-038-14W
18 CM - 11-038-18W
20 CM - 11-038-20W

BOYD CURVA EM S
VASCULAR



12 CM - 11-072-12

SERRILHADA
12 CM - 11-072-12S

SPECIAL LINE
12 CM - 11-072-12SSL
14 CM - 11-072-14SSL

WÍDIA
12 CM - 11-072-12W

CONVERSE



SERRILHADA
18 CM - 11-084-18S

SPECIAL LINE
18 CM - 11-084-18SSL

WÍDIA
18 CM - 11-084-18W

COTTLE



20 CM - 11-010-20

BALIÚ



POTTS SMITH



25°
18 CM - 11-360-25

WÍDEA
18 CM - 11-360-25W



45°
18 CM - 11-360-45

WÍDEA
18 CM - 11-360-45W



60°
18 CM - 11-360-60

WÍDEA
18 CM - 11-360-60W

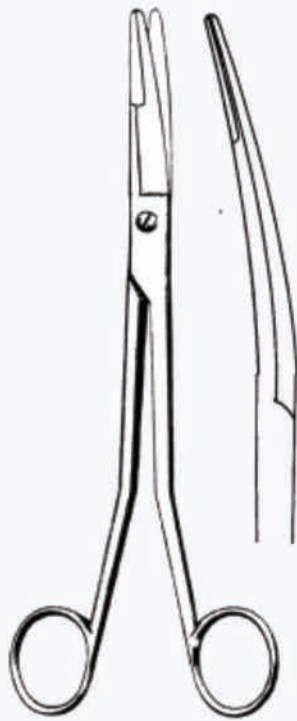

REES

18 CM - 11-444-18

WÍDEA
18 CM - 11-444-18W

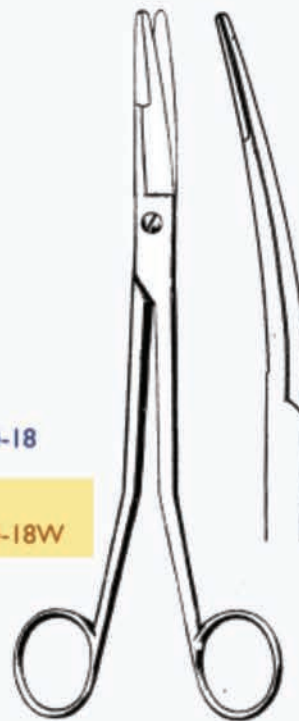

REES SERRILHADA

18 CM - 11-444-18S
20 CM - 11-444-20S

SPECIAL LINE
18 CM - 11-444-18SSL
20 CM - 11-444-20SSL

WÍDEA
18 CM - 11-444-18W
20 CM - 11-444-20W

12

TÊM A FUNÇÃO DE AUXILIAR O CIRURGIAO NA
PREENSÃO DE TECIDOS E FIOS, FABRICADAS
COM SERRILHAS E DENTES DE RATO.



12 CM - 12-691-12
14 CM - 12-691-14
16 CM - 12-691-16
18 CM - 12-691-18

WÍDEA

12 CM - 12-691-12W
14 CM - 12-691-14W
16 CM - 12-691-16W

**SEMKEN
SERRILHADA**



12 CM - 12-690-12
14 CM - 12-690-14
16 CM - 12-690-16

**SEMKEN
C/DENTE**



18 CM - 12-589-18
20 CM - 12-589-20
25 CM - 12-589-25
30 CM - 12-589-30

WÍDEA

18 CM - 12-589-18W
20 CM - 12-589-20W
25 CM - 12-589-25W
30 CM - 12-589-30W

**POTTS SMITH
SERRILHADA**



18 CM - 12-588-18
20 CM - 12-588-20
25 CM - 12-588-25

**POTTS SMITH
C/DENTE**



12 CM - 12-180-12
15 CM - 12-180-15

MICRO

12 CM - 12-181-12
15 CM - 12-181-15

WÍDEA

12 CM - 12-180-12W
15 CM - 12-180-15W

12 CM - 12-181-12W
15 CM - 12-181-15W

**ADSON
SERRILHADA**



12 CM - 12-120-12
15 CM - 12-120-15

MICRO

12 CM - 12-121-12
15 CM - 12-121-15

WÍDEA

12 CM - 12-120-12W
15 CM - 12-120-15W

12 CM - 12-121-12W
15 CM - 12-121-15W

**ADSON
C/DENTE**

PINÇAS DISSECÇÃO



12 CM - 12-060-12
15 CM - 12-060-15

ADSON
BROWN



12 CM - 12-210-00

ADSON (RELOJOEIRO)
LISA RETA



12 CM - 12-210-45

ADSON (RELOJOEIRO)
LISA ANGULADA



10 CM - 12-422-10
12 CM - 12-422-12
14 CM - 12-422-14
16 CM - 12-422-16
18 CM - 12-422-18
20 CM - 12-422-20
25 CM - 12-422-25
30 CM - 12-422-30

DISSECÇÃO
STANDART



10 CM - 12-420-10
12 CM - 12-420-12
14 CM - 12-420-14
16 CM - 12-420-16
18 CM - 12-420-18
20 CM - 12-420-20
25 CM - 12-420-25
30 CM - 12-420-30

DISSECÇÃO C/DENTE
STANDART



18 CM - 12-445-18
20 CM - 12-445-20

GERALD



18 CM - 12-444-18
20 CM - 12-444-20

GERALD
C/DENTES



19 CM - 12-468-19
21 CM - 12-468-21

PINÇA
JANSEN



10 CM - 12-411-10

IRIS GRAEFE
RETA



10 CM - 12-410-10

IRIS GRAEFE
CURVA



14 CM - 12-510-14
16 CM - 12-510-16

LUCAE

PINÇAS DISSECÇÃO



16 CM - 12-570-16
18 CM - 12-570-18
20 CM - 12-570-20
30 CM - 12-570-30

NELSON



18 CM - 12-696-18
20 CM - 12-696-20
25 CM - 12-696-25

SINGLEY TUTTLE



16 CM - 12-660-16
20 CM - 12-660-20
25 CM - 12-660-25

RUSSA PATA
DE GATO



18 CM - 12-587-18
20 CM - 12-587-20
25 CM - 12-587-25

POTTS SMITH
BAIONETA C/DENTE

13

TÊM A FUNÇÃO DE PROMOVER A HEMOSTASIA OU ESTANCAMENTO DO SANGUE DURANTE O ATO CIRÚRGICO, SÃO UTILIZADAS DEPENDENDO DO MODELO PARA PINÇAR VASOS, SEGURAR FIOS DE SUTURA E PRENDER TECIDOS.



10 CM
13-493-10

HALSTEAD-HARTMANN



10 CM
13-497-10

10 CM
13-496-10

HALSTEAD-HARTMANN MICRO



12 CM
13-493-12

12 CM
13-492-12

HALSTEAD
MOSQUITO



12 CM
13-497-12

12 CM
13-496-12

HALSTEAD
MOSQUITO MICRO

PINÇAS HEMOSTATICAS



KELLY

14 CM - 13-421-14
16 CM - 13-421-16
18 CM - 13-421-18

DELICADA
14 CM - 13-423-14
16 CM - 13-423-16
18 CM - 13-423-18



14 CM - 13-420-14
16 CM - 13-420-16
18 CM - 13-420-18

DELICADA
14 CM - 13-422-14
16 CM - 13-422-16
18 CM - 13-422-18

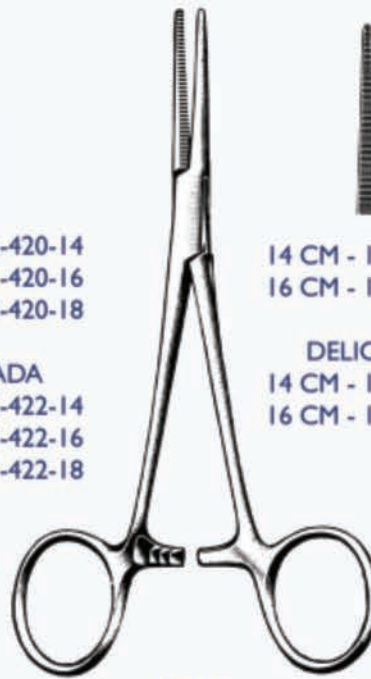

CRILE

14 CM - 13-241-14
16 CM - 13-241-16

DELICADA
14 CM - 13-243-14
16 CM - 13-243-16



14 CM - 13-240-14
16 CM - 13-240-16

DELICADA
14 CM - 13-242-14
16 CM - 13-242-16

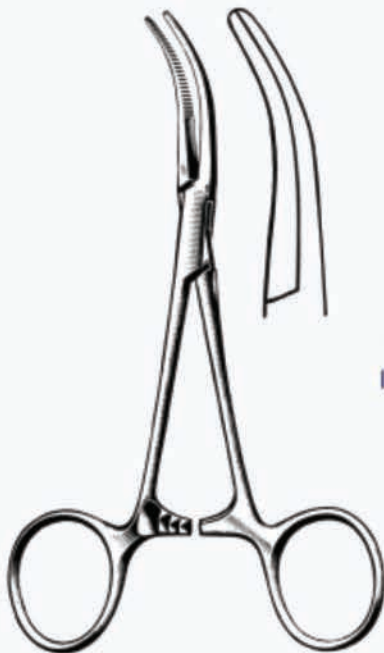

DANDY

14 CM
13-320-14



LONGUETTE

18 CM - 13-463-18
21 CM - 13-463-21
23 CM - 13-463-23

DELICADA
18 CM - 13-465-18
21 CM - 13-465-21
23 CM - 13-465-23



18 CM - 13-462-18
21 CM - 13-462-21
23 CM - 13-462-23

DELICADA
18 CM - 13-464-18
21 CM - 13-464-21
23 CM - 13-464-23



14 CM - 13-480-14
16 CM - 13-480-16
18 CM - 13-480-18
21 CM - 13-480-21
23 CM - 13-480-23

MIXTER DELICADA

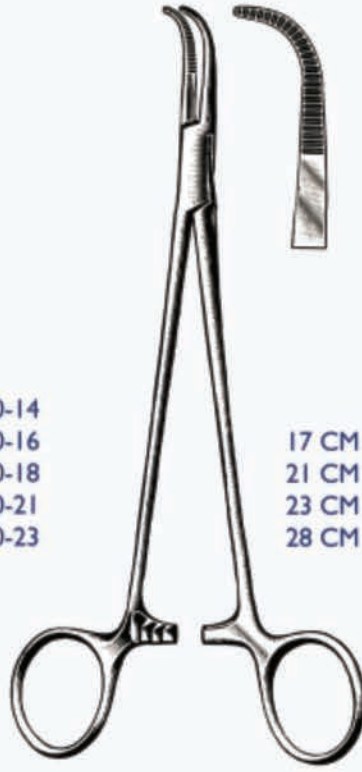

17 CM - 13-482-17
21 CM - 13-482-21
23 CM - 13-482-23
28 CM - 13-482-28

MIXTER BRUTA



13 CM - 13-408-13
15 CM - 13-408-15
17 CM - 13-408-17
20 CM - 13-408-20
23 CM - 13-408-23
28 CM - 13-408-28

GEMINI



24 CM - 13-222-24

CRAFFORD CURVA



21 CM - 13-503-21
24 CM - 13-503-24

MOYNIHAN



20 CM - 13-483-20

NEGUS

PINÇAS HEMOSTATICAS



SCHNIDT



ROCHESTER PEAN
CURVA



ROCHESTER PEAN
RETA

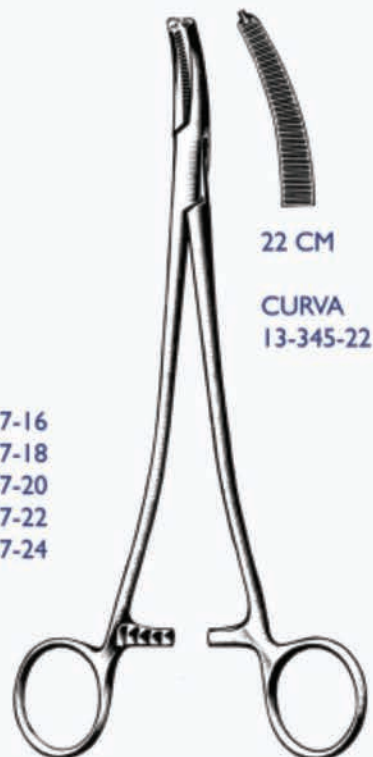

FAURE



14 CM - 13-433-14
16 CM - 13-433-16
18 CM - 13-433-18
20 CM - 13-433-20
22 CM - 13-433-22
24 CM - 13-433-24

KOCHER RETA



14 CM - 13-432-14
16 CM - 13-432-16
18 CM - 13-432-18
20 CM - 13-432-20
22 CM - 13-432-22
24 CM - 13-432-24

KOCHER CURVA

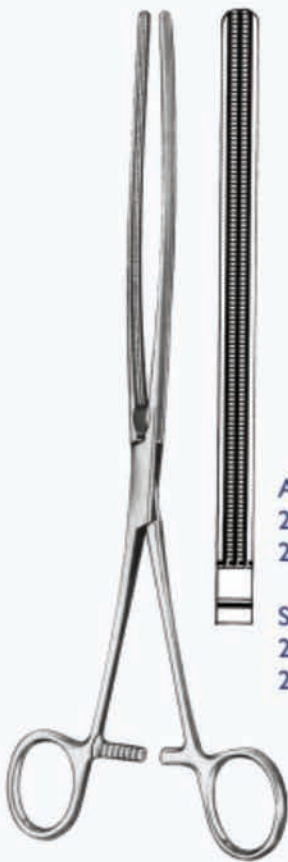

ATRAUMA
22 CM - 48-181-22
25 CM - 48-181-25

SERRILHADA
22 CM - 48-241-22
25 CM - 48-241-25

**KOCHER INTESTINAL
RETA**



ATRAUMA
22 CM - 48-180-22
25 CM - 48-180-25

SERRILHADA
22 CM - 48-240-22
25 CM - 48-240-25

**KOCHER INTESTINAL
CURVA**



15 CM - 13-550-15
20 CM - 13-550-20

PENNINGTON

PINÇAS HEMOSTATICAS



C/ 1 CM BOCA
21 CM - 13-330-21
23 CM - 13-330-23

2,5 CM BOCA
21 CM - 13-332-21
23 CM - 13-332-23

DUVAL



16 CM - 13-060-16
20 CM - 13-060-20
24 CM - 13-060-24

BABCOCK



14 CM
60-462-14

MARTEL



15 CM - 13-030-15
18 CM - 13-030-18
20 CM - 13-030-20
25 CM - 13-030-25

ALLIS

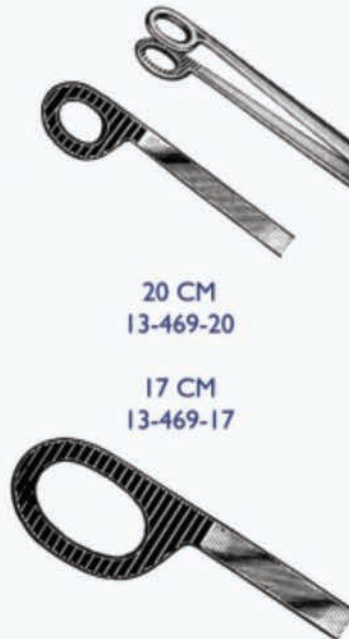

20 CM
13-469-20

17 CM
13-469-17

25 CM
13-469-25

MAGIL



25 CM
13-120-25

CHERON



20 CM - 13-180-20
25 CM - 13-180-25

COLLIN 1X2 DENTES

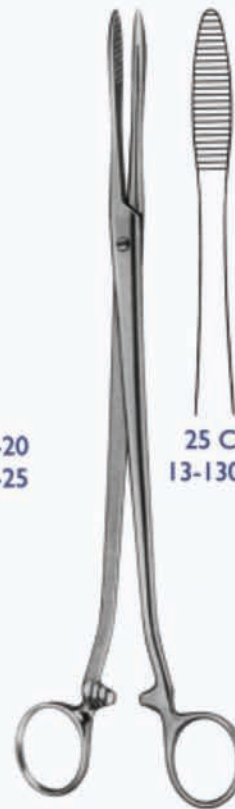

25 CM
13-130-25

COLLIN RETA



16 CM
13-209-16

COLLIN ANEL



18 CM - 13-391-18
20 CM - 13-391-20
24 CM - 13-391-24

FOERSTER RETA



18 CM - 13-390-18
20 CM - 13-390-20
24 CM - 13-390-24
30 CM - 13-390-30

FOERSTER CURVA

PINÇAS HEMOSTATICAS



14 CM - 13-538-14
16 CM - 13-538-16

PEAN MURPHY



30-780-18

REYNOLD P/TUBOS
LISA



30-782-18

REYNOLD P/TUBOS
SERRILHADA



25 CM
13-102-25

BOZEMANN



09 CM - 13-091-08
11 CM - 13-091-10
13 CM - 13-091-13
15 CM - 13-091-15

BACKHAUS

14

TÊM A FUNÇÃO DE EXPOR O CAMPO OPERATÓRIO, FACILITANDO A VISÃO DO CIRURGIÃO, PODEM SER AUTO-ESTÁTICOS E DE TRAÇÃO MANUAL CONTÍNUA.



16 CM
14-430-16

SENN MULLER
AGUDO



16 CM
14-431-16

SENN MULLER
ROMBO



14-156-14

DAVIS



N° 1 - 12X200mm
14-300-12

N° 2 - 14X200mm
14-300-14

N° 3 - 16X200mm
14-300-16

N° 4 - 18X200mm
14-300-18

KIRKLIN



06mm - 14-180-06
08mm - 14-180-08
10mm - 14-180-10
12mm - 14-180-12
14mm - 14-180-14
16mm - 14-180-16
18mm - 14-180-18

REVESTIDO

06mm - 70-008-06R
08mm - 70-008-08R
10mm - 70-008-10R
12mm - 70-008-12R
14mm - 70-008-14R
16mm - 70-008-16R
18mm - 70-008-18R

DESMARRES



RETO
18 CM
13-318-00

LOVE



45°
18 CM
13-318-45

LOVE



90°
18 CM
13-318-90

LOVE

AFASTADORES - GANCHOS - ESPÁTULAS - VALVAS



18 X 07mm
14-330-18



16 X 05mm
14-330-16



07 X 04mm
14-332-07



10 X 03mm
14-330-10



07 X 04mm
14-330-07



10 X 04mm
14-332-10

MEYERDING



GILLIES



DELICADO
14-672-01



FORTE
14-672-02



JOSEPH
SIMPLES



14-678-18



BLAIR-ROLLET
AGUDO



14-126-01



BLAIR-ROLLET
ROMBO



14-126-02



CONVERSE

12 CM
14-144-12



14-648-10



GANCHO DUPLO
ARTICULADO PONTA FINA
DE PENN



06mm
14-654-06



08mm
14-654-08



10mm
14-654-10

GANCHO DUPLO
C/BOLA



06mm
14-660-06



08mm
14-660-08



10mm
14-660-10

GANCHO DUPLO
PONTA FINA



06mm
14-666-06



08mm
14-666-08



10mm
14-666-10

GANCHO DUPLO
PONTA ROMBA



10 X 06mm
14-312-10

17 X 05mm
14-312-17

20 X 06mm
14-312-20

22 X 08mm
14-312-22

LANGENBECK MINI



12 CM
14-682-12

26 CM
14-682-26

GANCHO P/MAMA
C/ARGOLA

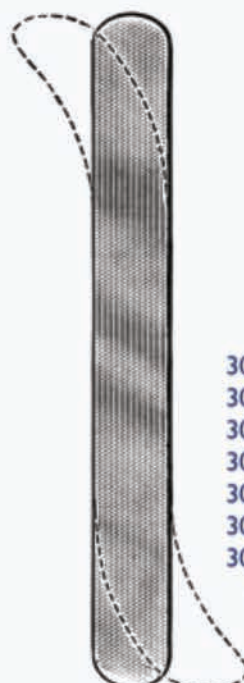

300 X 20mm - 14-600-20
300 X 25mm - 14-600-25
300 X 30mm - 14-600-30
300 X 35mm - 14-600-35
300 X 40mm - 14-600-40
300 X 45mm - 14-600-45
300 X 50mm - 14-600-50

ESPÁTULA
MALEÁVEL

AFASTADORES - GANCHOS - ESPÁTULAS - VALVAS



45 + 60 X 28 CM
14-601-00

ESPATULA REVERDIN
BAIONETA

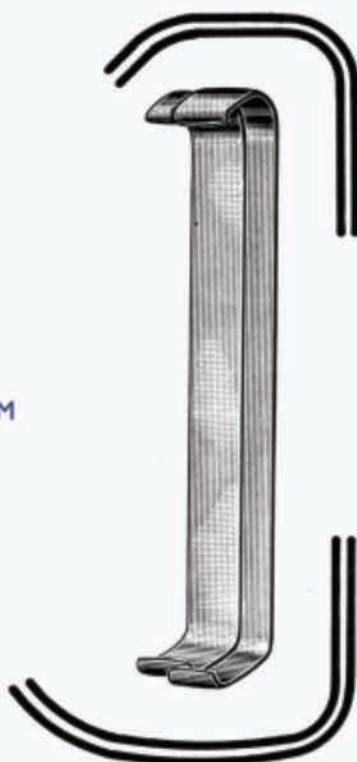

FARABEU

07 X 100mm - 14-216-07
10 X 120mm - 14-216-10
13 X 125mm - 14-216-13
15 X 140mm - 14-216-15
20 X 170mm - 14-216-20



PARKER

14 CM - 19 X 15 mm - 14-402-19
14 CM - 22 X 15 mm - 14-402-22



SOFIELD

JOGO COMPLETO
14-544-00

150 X 45 X 35 - 14-544-15
160 X 60 X 45 - 14-544-16
170 X 65 X 55 - 14-544-17
180 X 85 X 60 - 14-544-18
190 X 100 X 65 - 14-544-19
200 X 115 X 75 - 14-544-20



N° 1
24 X 20 mm
14-408-01



N° 2
33 X 29 mm
14-408-02



N° 3
40 X 38 mm
14-408-03



N° 4
50 X 22 mm
14-408-04



RICHARDSON 24 CM



80 X 45mm
14-690-00

BALFOUR
VALVA SUPRA PÚBICA



100 X 70mm
14-691-30

BALFOUR
VALVA

AFASTADORES - GANCHOS - ESPÁTULAS - VALVAS



HARRINGTON

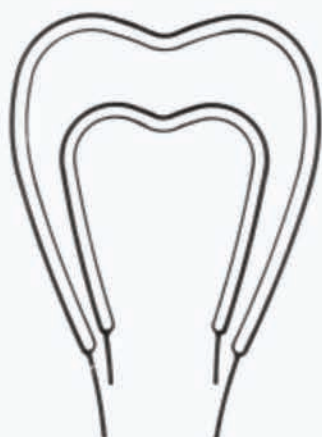

30 CM
127 X 62 X 320mm
14-264-30

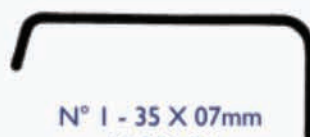

Nº 1 - 35 X 07mm
14-306-01

Nº 2 - 35 X 10mm
14-306-02

Nº 3 - 35 X 15mm
14-306-03



KOCHER
LANGENBECK

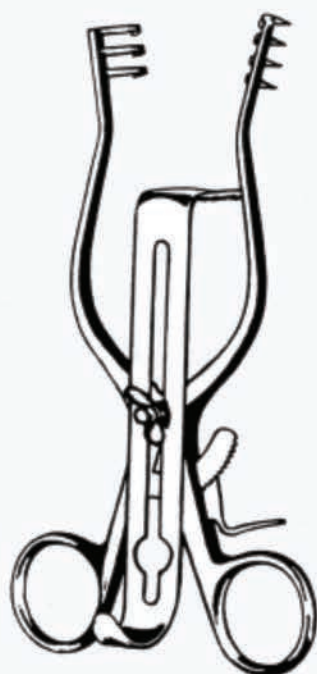

HENLEY

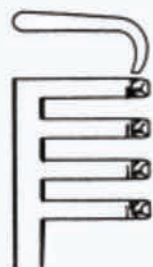

14 CM - 14-283-14
17 CM - 14-283-17



14 CM - 14-282-14
17 CM - 14-282-17



16 x 19 mm
16 x 25 mm
16 x 32 mm

40 X 18 mm - 20 CM
14-414-01



50 X 15mm - 22 CM
14-414-02



57 X 25mm - 22 CM
14-414-03



120 X 20mm - 22 CM
14-414-20



SAUERBRUCH



DOYEN VALVA

045 X 060mm
14-745-60

045 X 120mm
14-745-12

060 X 120mm
14-760-12

060 X 060mm
14-760-60

060 X 090mm
14-745-90

ADULTO - 60 X 60 mm
INFANTIL - 40 X 40 mm

DENNIS BROWNE



ADULTO - 60 X 45 mm
INFANTIL - 40 X 30 mm

ADULTO - 60 X 45 mm
INFANTIL - 40 X 30 mm

ADULTO - 60 X 60 mm
INFANTIL - 40 X 40 mm

ADULTO - 14-174-02
Diametro do Arco - 300 X 240 mm

INFANTIL - 14-174-01
Diametro do Arco - 190 X 160 mm

AFASTADORES - GANCHOS - ESPÁTULAS - VALVAS



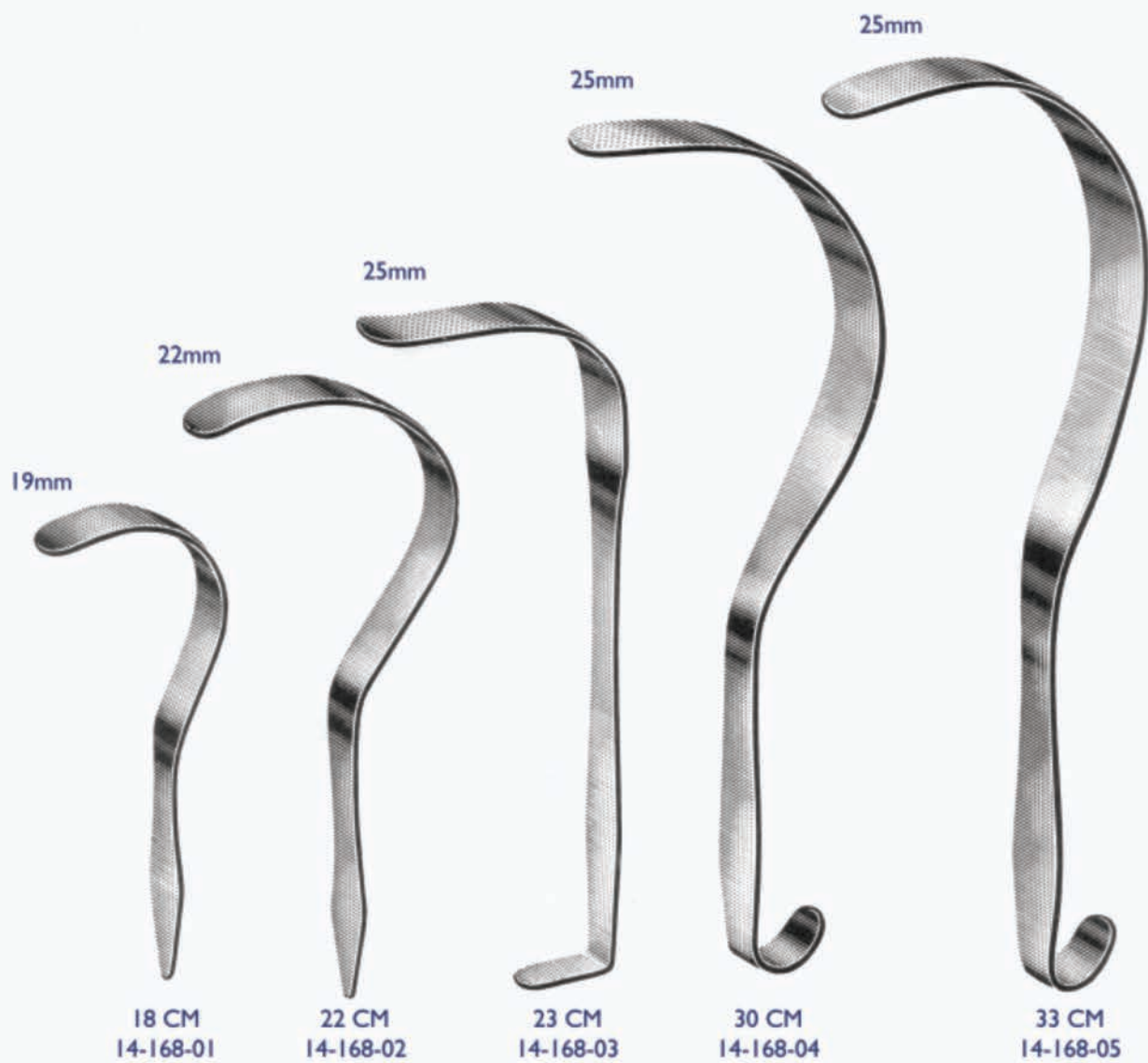

DEAVER

AFASTADORES - GANCHOS - ESPÁTULAS - VALVAS

25mm



36 CM
14-168-06

38mm



30 CM
14-168-07

50mm



30 CM
14-168-08

75mm



30 CM
14-168-09

DEAVER



4 DENTES
14-288-04

ISRAEL



5 DENTES
14-288-05

6 DENTES
14-288-06



2 DENTES
20-301-02

OLLIER

AFASTADORES - GANCHOS - ESPÁTULAS - VALVAS

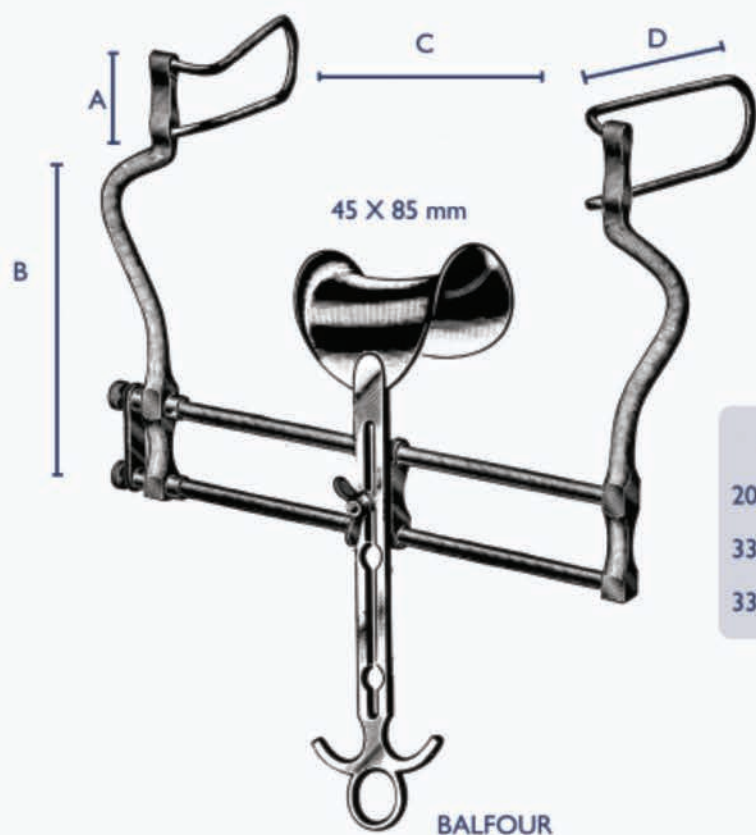

A	B	C	D	CÓDIGO
20 mm	170 mm	180 mm	40 mm	14-108-00
33 mm	200 mm	200 mm	80 mm	14-108-02
33 mm	200 mm	240 mm	100 mm	14-108-03

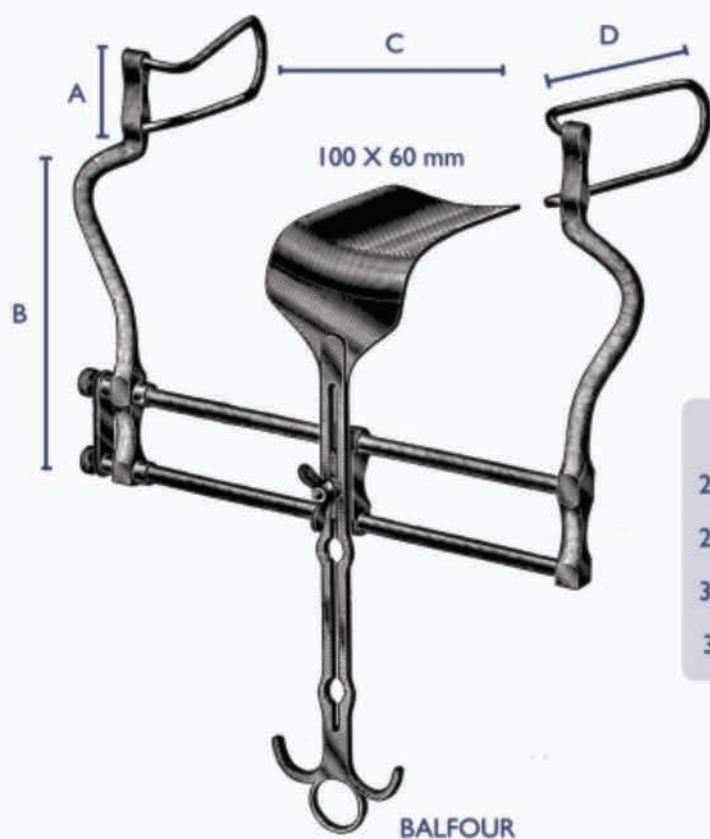

A	B	C	D	CODIGO
20 mm	170 mm	180 mm	40 mm	14-114-00
20 mm	200 mm	180 mm	60 mm	14-114-01
33 mm	200 mm	200 mm	80 mm	14-114-02
33mm	200 mm	240 mm	100 mm	14-114-03

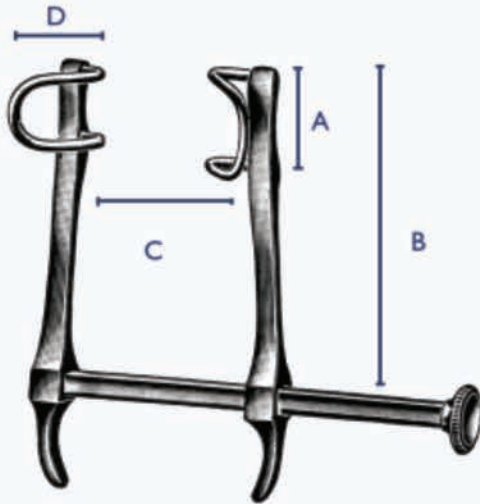

GOSSET BABY

A	B	C	D	CODIGO
20 mm	100 mm	100 mm	40 mm	14-252-00

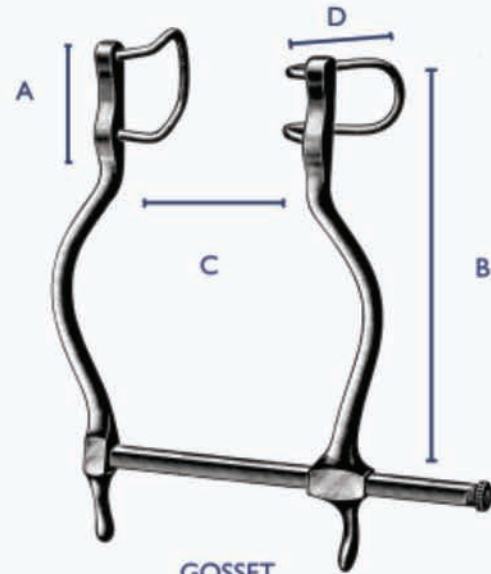

GOSSET

A	B	C	D	CODIGO
30 mm	150 mm	120 mm	60 mm	14-252-01
33 mm	200 mm	140 mm	80 mm	14-252-02
33 mm	200 mm	200 mm	100 mm	14-252-03



ALM

AGUDO
14-060-10

ROMBO
14-061-10



SPRING

07 CM - 07 X 10mm
14-444-07

09 CM - 10 X 15mm
14-444-09

12 CM - 15 X 20mm
14-444-12

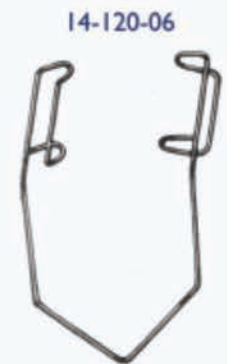

BARRAQUER
BLEFAROSTATO

AFASTADORES - GANCHOS - ESPÁTULAS - VALVAS

14-295-11



JANSEN ROMBO

14-294-11



JANSEN AGUDO

AGUDO
14 CM - 14-570-14
18 CM - 14-570-18
21 CM - 14-570-21

ROMBO
14 CM - 14-571-14
18 CM - 14-571-18
21 CM - 14-571-21

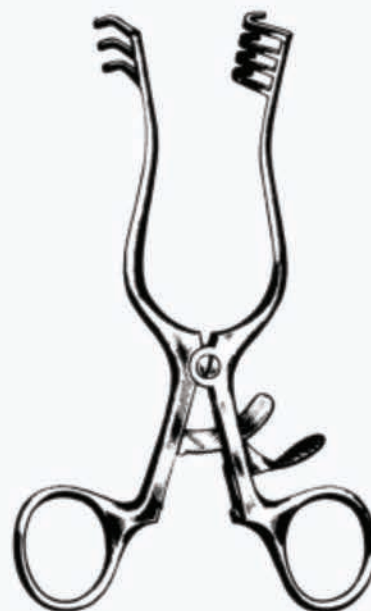

WEITLANER



SCALP

AGUDO
14 CM - 14-420-14
16 CM - 14-420-16

ROMBO
14 CM - 14-421-14
16 CM - 14-421-16



GELPI

14 CM - 14-240-14
16 CM - 14-240-16
18 CM - 14-240-18



14-324-00

MAYO ADAMS

AGUDO
31 CM - 14-012-31

ROMBO
31 CM - 14-013-31



ADSON

AFASTADORES - GANCHOS - ESPÁTULAS - VALVAS



32 CM - 7 X 7
14-048-32 AGUDO
14-049-32 ROMBO

ADSON BECKMANN
EATON



17 CM - 4 X 4
14-041-17 AGUDO
14-042-17 ROMBO

ADSON BECKMANN



31 CM - 4 X 4
14-041-31 AGUDO
14-042-31 ROMBO

ADSON BECKMANN

LADO ESQUERDO

17 CM
14-321-17



LADO DIREITO

17 CM
14-320-17



MARKHAN MEYERDING



14 CM - 14-368-14
17 CM - 14-368-17
20 CM - 14-368-20
31 CM - 14-368-31

MEYERDING

AFASTADORES - GANCHOS - ESPÁTULAS - VALVAS

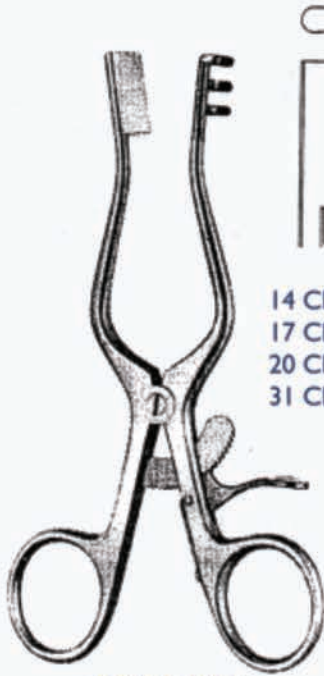

14 CM - 14-375-14
17 CM - 14-375-17
20 CM - 14-375-20
31 CM - 14-375-31

MEYERDING
ESQUERDO

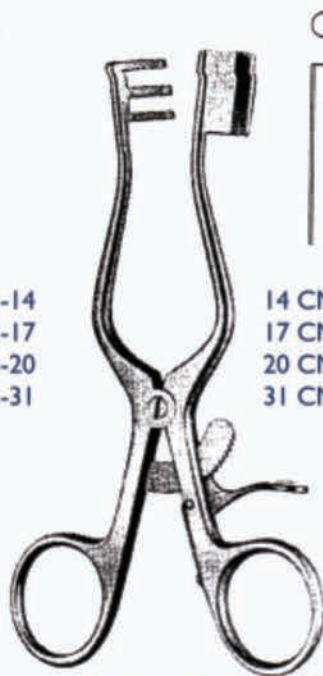

14 CM - 14-374-14
17 CM - 14-374-17
20 CM - 14-374-20
31 CM - 14-374-31

MEYERDING
DIREITO

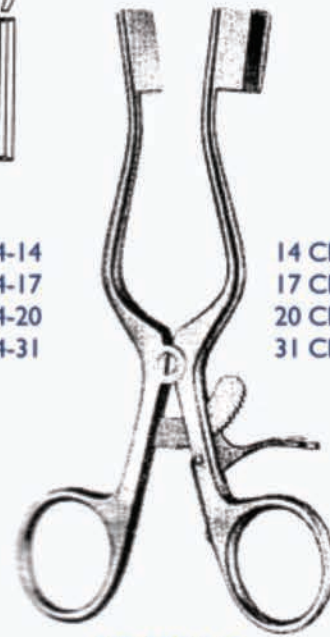

14 CM - 14-368-14
17 CM - 14-368-17
20 CM - 14-368-20
31 CM - 14-368-31

MEYERDING
DUPLO



17 CM - 14-362-17
31 CM - 14-362-31

MEYERDING
ESQUERDO



17 CM - 14-361-17
31 CM - 14-361-31

MEYERDING
DIREITO



17 CM - 14-360-17
31 CM - 14-360-31

MEYERDING
DUPLO ARTICULADO

14-18



Afastador Universal Lang

Extremamente versátil, com diferentes tamanhos de aros, o Afastador Universal fabricado pela LANG tem um mecanismo de fixação à mesa resistente e seguro. Aceita vários tipos de valvas que são fixadas ao aro por um sistema exclusivo que torna o conjunto adequado a quase todos os procedimentos cirúrgicos.

O Afastador Universal Oferece:

Excelente visão do campo operatório;

Redução do tempo da Cirurgia;

Elimina uso de auxiliares com a consequente redução de custos.

Tranquilidade e segurança para o cirurgião.

Adaptável a diversas modalidades cirúrgicas como: cirurgia geral, cirurgia bariátrica, transplantes de órgãos e etc...

AFASTADORES - GANCHOS - ESPÁTULAS - VALVAS



45 X 60 - 14-872-01
45 X 90 - 14-872-02
45 X 120 - 14-872-03
60 X 60 - 14-872-04
60 X 90 - 14-872-05
60 X 120 - 14-872-06

DOYEN

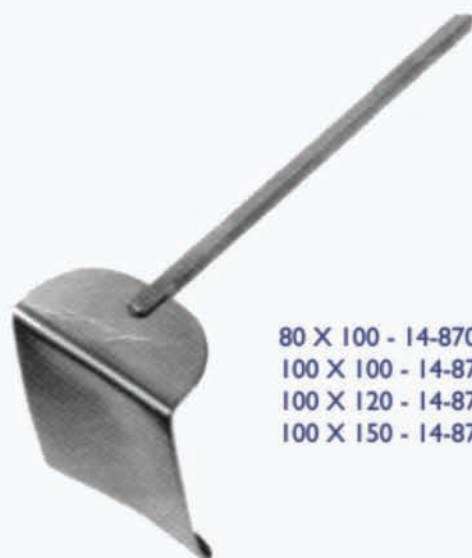

80 X 100 - 14-870-01
100 X 100 - 14-870-02
100 X 120 - 14-870-03
100 X 150 - 14-870-04

MIKULICZ

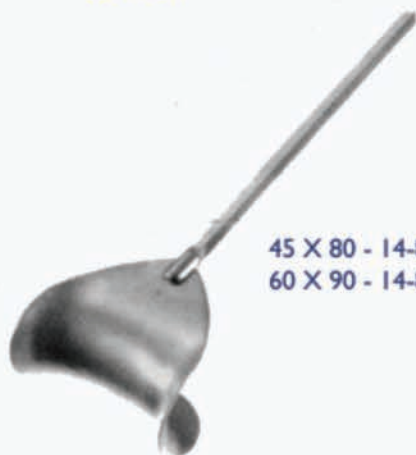

45 X 80 - 14-876-01
60 X 90 - 14-876-02

SUPRA PUBIANA



50 X 150 - 14-862-01
50 X 200 - 14-862-02
80 X 150 - 14-862-03
80 X 200 - 14-862-04
100 X 200 - 14-862-05
100 X 250 - 14-862-06

MALEÁVEL

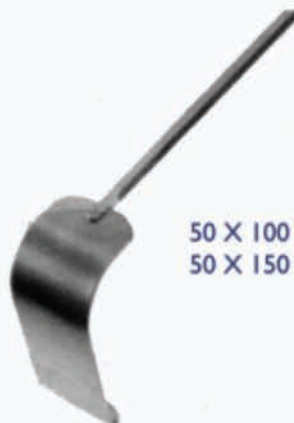

50 X 100 - 14-864-01
50 X 150 - 14-864-02

LANGENBECK



HASTE PRINCIPAL DO AFASTADOR
UNIVERSAL

14-460-05

HASTE DO ARO DO AFASTADOR
UNIVERSAL

14-460-06



PRESILHA DAS HASTES
14-460-04

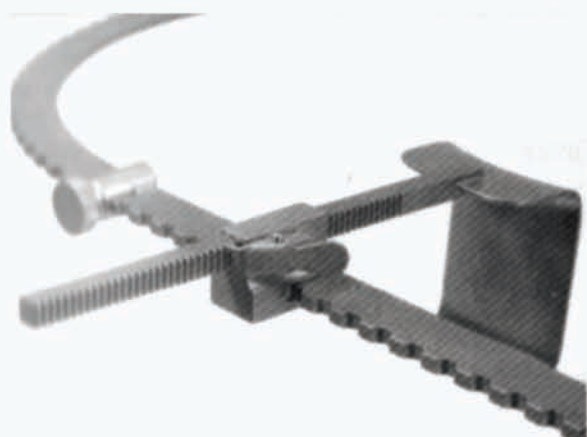

PRESILHA DAS VALVAS
14-890-01



AROS PARA AFASTADOR
UNIVERSAL

ANEL OVAL - 26 X 35 CM
14-850-35

ANEL OVAL - 26 X 28 CM
14-850-28

ANEL OVAL COM EXTENSOR - 26 X 48 CM
14-850-48

15



ESTILETE

2mm
16 CM - 15-185-16
18 CM - 15-185-18
20 CM - 15-185-20
25 CM - 15-185-25



BIOLIVAR



1mm
16 CM - 15-181-16
18 CM - 15-181-18
20 CM - 15-181-20
25 CM - 15-181-25



2mm
16 CM - 15-182-16
18 CM - 15-182-18
20 CM - 15-182-20
25 CM - 15-182-25

TENTACÂNULA - ESTILETES - CLIPES



15-360-14

PORTA ALGODÃO
C/ ARGOLA MALEÁVEL



14 CM - 15-366-14
18 CM - 15-366-18
28 CM - 15-366-28

PORA ALGODÃO
C/CABO E ROSCA



15 CM
14-660-15

TENTACÂNULA

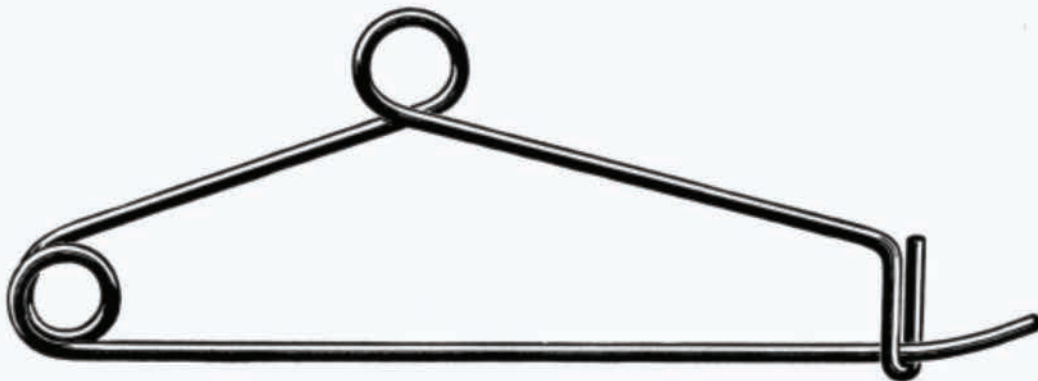

15-180-00

CLIP MAYO BUNT

16



3.0 mm - 16-030-30
3.5 mm - 16-030-35
4.0 mm - 16-030-40

ADSON



8 mm - 16-042-30
PONTA PROTEGIDA
8 mm - 16-044-30

COOLEY
CURVO



8 mm - 16-043-30
PONTA PROTEGIDA
8 mm - 16-045-30

COOLEY
RETO



MIELOGRAMA
1,5 mm - 16-006-15
1,8 mm - 16-006-18
2,0 mm - 16-006-20

AGULHAS E ASPIRADORES



FRAZIER



FRAZIER C/PONTA PROTEGIDA
E CONTROLE DE FLUXO



POOLE CURVO



POOLE RETO



YANKAUER

17

Modelo de Apresentação das peças com WÍDIA.



A micro aderência da wídia oferece longa duração para uma melhor segurança da agulha em uma sutura.

Braço forte para um alinhamento e flexibilidade mais consistente.

Anéis com marcação em dourado para fácil identificação.

Dependendo do seu uso as peças LANG são equipadas com a seguinte variedade de pontas de wídia.

Regular - 0,5 mm
para uso em suturas até 4-0.



Fina - 0,4 mm
para uso com agulhas delicadas em suturas tam. 5-0 e 6-0.

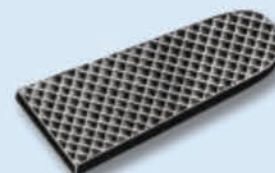

Extra-Fina - 0,3 mm
para usar com micro-agulhas e suturas até 10-0.

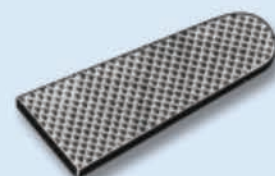



MAYO HEGAR



12 CM - 17-012-12
 14 CM - 17-012-14
 16 CM - 17-012-16
 18 CM - 17-012-18
 20 CM - 17-012-20
 25 CM - 17-012-25
 30 CM - 17-012-30

DELICADO
 12 CM - 17-014-12
 14 CM - 17-014-14
 16 CM - 17-014-16
 18 CM - 17-014-18
 20 CM - 17-014-20
 25 CM - 17-014-25
 30 CM - 17-014-30



MAYO HEGAR
C/WÍDIA



12 CM - 17-012-12W
 14 CM - 17-012-14W
 16 CM - 17-012-16W
 18 CM - 17-012-18W
 20 CM - 17-012-20W
 25 CM - 17-012-25W
 30 CM - 17-012-30W

DELICADO
 12 CM - 17-014-12W
 14 CM - 17-014-14W
 16 CM - 17-014-16W
 18 CM - 17-014-18W
 20 CM - 17-014-20W
 25 CM - 17-014-25W
 30 CM - 17-014-30W



CRILEWOOD



15 CM - 17-015-15
 18 CM - 17-015-18



CRILEWOOD C/WÍDIA



15 CM - 17-015-15W
 18 CM - 17-015-18W



14 CM
17-016-14

BAUMGARTNER



14 CM
17-016-14W

BAUMGARTNER C/WÍDIA



20 CM - 17-018-20W
25 CM - 17-018-25W
30 CM - 17-018-30W

HEANEY CURVO
C/WÍDEA



18 CM - 17-021-18W
20 CM - 17-021-20W
23 CM - 17-021-23W
25 CM - 17-021-25W
30 CM - 17-021-30W

DEBAKEY C/WÍDIA



25 CM
17-072-25W

FINOCHIETTO C/WÍDIA



18 CM
17-120-18W

20CM
17-120-20W

P/ FIO DE AÇO C/WÍDIA



1mm

14 CM - 17-181-14W
16 CM - 17-181-16W
18 CM - 17-181-18W
20 CM - 17-181-20W
25 CM - 17-181-25W

RYDER C/WÍDIA



2mm

14 CM - 17-182-14W
16 CM - 17-182-16W
18 CM - 17-182-18W
20 CM - 17-182-20W
25 CM - 17-182-25W

RYDER C/WÍDIA



14 CM - 17-050-14W
20 CM - 17-050-20W

MATHIEU C/WÍDIA



12 CM - 17-016-12W
14 CM - 17-016-14W
16 CM - 17-016-16W
18 CM - 17-016-18W
20 CM - 17-016-20W
23 CM - 17-016-23W
25 CM - 17-016-25W
30 CM - 17-016-30W

VASCULAR C/WÍDIA



1mm

14 CM - 17-181-14W
16 CM - 17-181-16W
18 CM - 17-181-18W
20 CM - 17-181-20W
25 CM - 17-181-25W

RYDER C/WÍDIA



2mm

14 CM - 17-182-14W
16 CM - 17-182-16W
18 CM - 17-182-18W
20 CM - 17-182-20W
25 CM - 17-182-25W

RYDER C/WÍDIA



14 CM - 17-050-14W
20 CM - 17-050-20W

MATHIEU C/WÍDIA



12 CM - 17-016-12W
14 CM - 17-016-14W
16 CM - 17-016-16W
18 CM - 17-016-18W
20 CM - 17-016-20W
23 CM - 17-016-23W
25 CM - 17-016-25W
30 CM - 17-016-30W

VASCULAR C/WÍDIA



**BARRAQUER
SEM TRAVA**



14 CM - 17-032-14
18 CM - 17-032-18
22 CM - 17-032-22

MICRO

14 CM - 17-038-14
18 CM - 17-038-18
22 CM - 17-038-22



14 CM - 17-033-14
18 CM - 17-033-18
22 CM - 17-033-22

MICRO

14 CM - 17-039-14
18 CM - 17-039-18
22 CM - 17-039-22



**BARRAQUER
SEM TRAVA C/WÍDIA**



14 CM - 17-032-14W
18 CM - 17-032-18W
22 CM - 17-032-22W

MICRO

14 CM - 17-038-14W
18 CM - 17-038-18W
22 CM - 17-038-22W



14 CM - 17-033-14W
18 CM - 17-033-18W
22 CM - 17-033-22W

MICRO

14 CM - 17-039-14W
18 CM - 17-039-18W
22 CM - 17-039-22W



BARRAQUER
COM TRAVA



14 CM - 17-030-14
18 CM - 17-030-18
22 CM - 17-030-22

MICRO

14 CM - 17-036-14
18 CM - 17-036-18
22 CM - 17-036-22



14 CM - 17-031-14
18 CM - 17-031-18
22 CM - 17-031-22

MICRO

14 CM - 17-037-14
18 CM - 17-037-18
22 CM - 17-037-22



BARRAQUER
COM TRAVA C/WÍDIA



14 CM - 17-030-14W
18 CM - 17-030-18W
22 CM - 17-030-22W

MICRO

14 CM - 17-036-14W
18 CM - 17-036-18W
22 CM - 17-036-22W



14 CM - 17-031-14W
18 CM - 17-031-18W
22 CM - 17-031-22W

MICRO

14 CM - 17-037-14W
18 CM - 17-037-18W
22 CM - 17-037-22W



CASTROVIEJO
SEM TRAVA



14 CM - 17-062-14
18 CM - 17-062-18
22 CM - 17-062-22

DELICADA

14 CM - 17-068-14
18 CM - 17-068-18
22 CM - 17-068-22



14 CM - 17-063-14
18 CM - 17-063-18
22 CM - 17-063-22

DELICADA

14 CM - 17-069-14
18 CM - 17-069-18
22 CM - 17-069-22



CASTROVIEJO
SEM TRAVA C/WÍDIA



14 CM - 17-062-14W
18 CM - 17-062-18W
22 CM - 17-062-22W

DELICADA

14 CM - 17-068-14W
18 CM - 17-068-18W
22 CM - 17-068-22W



14 CM - 17-063-14W
18 CM - 17-063-18W
22 CM - 17-063-22W

DELICADA

14 CM - 17-069-14W
18 CM - 17-069-18W
22 CM - 17-069-22W



CASTROVIEJO
COM TRAVA



14 CM - 17-060-14
18 CM - 17-060-18
22 CM - 17-060-22

DELICADA

14 CM - 17-066-14
18 CM - 17-066-18
22 CM - 17-066-22



14 CM - 17-061-14
18 CM - 17-061-18
22 CM - 17-061-22

DELICADA

14 CM - 17-067-14
18 CM - 17-067-18
22 CM - 17-067-22



CASTROVIEJO
COM TRAVA COM VÍDIA



14 CM - 17-060-14W
18 CM - 17-060-18W
22 CM - 17-060-22W

DELICADA

14 CM - 17-066-14W
18 CM - 17-066-18W
22 CM - 17-066-22W



14 CM - 17-061-14W
18 CM - 17-061-18W
22 CM - 17-061-22W

DELICADA

14 CM - 17-067-14W
18 CM - 17-067-18W
22 CM - 17-067-22W

20



23 CM
20-018-23

PINÇA
WOLFF



28 CM
20-012-28

HENNING
ABRE-GESSO



17 CM - 11-192-17
20 CM - 11-192-20

SERRILHADA
17 CM - 11-192-17S
20 CM - 11-192-20S

TESOURA
LISTER



12 CM - 11-831-12

TESOURA
UNIVERSAL
P/ FIO DE AÇO

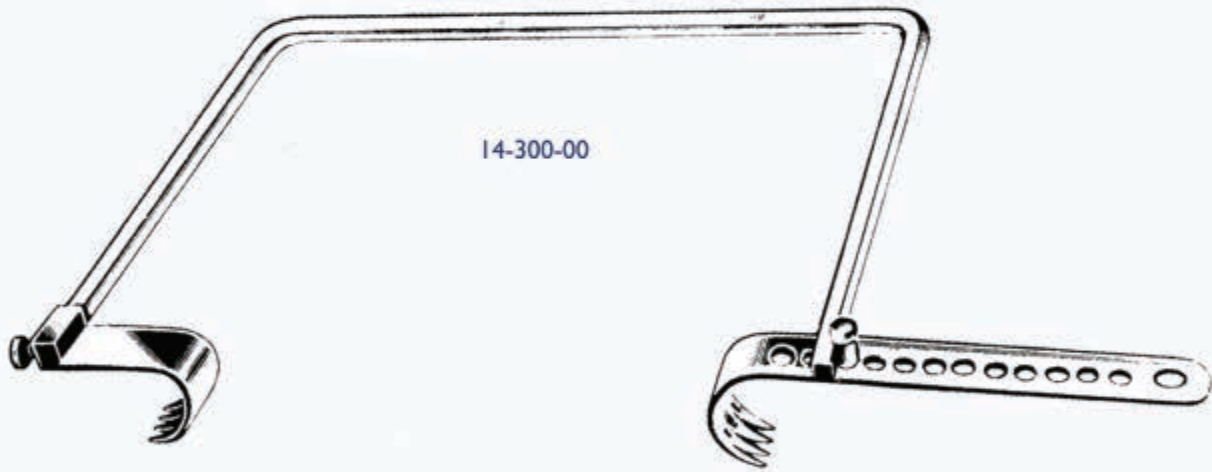

14-300-00

AFASTADOR
NORTE-SUL



JOGO COMPLETO
20-020-06

150 X 45 X 35 - 20-020-15
160 X 60 X 45 - 20-020-16
170 X 65 X 55 - 20-020-17
180 X 85 X 60 - 20-020-18
190 X 100 X 65 - 20-020-19
200 X 115 X 75 - 20-020-20

AFASTADOR
SOFIELD



14 CM - 20-036-14
18 CM - 20-036-18

BAILEY
APROXIMADOR DE
COSTELAS



18 CM
17-120-18W
20 CM
17-120-20W

PORTA AGULHA
P/ FIO DE AÇO



19 CM - 20-102-19
22 CM - 20-102-22

COSTÓTOMO
GLUCK



22 CM - 20-120-22

COSTÓTOMO
STANDART



18 CM
20-463-18

PINÇA GOIVA
LUER RETA



18 CM
20-462-18

PINÇA GOIVA
LUER CURVA



**PINÇA GOIVA
BEYER RETA**

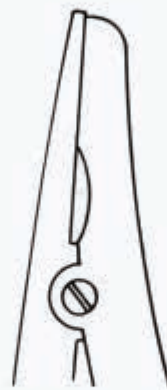

**PINÇA GOIVA
BEYER CURVA**



**PINÇA GOIVA
ZAUFAL-JANSEN**



**PINÇA GOIVA
STILLE LUER
RETA**



**PINÇA GOIVA
STILLE LUER
CURVA**

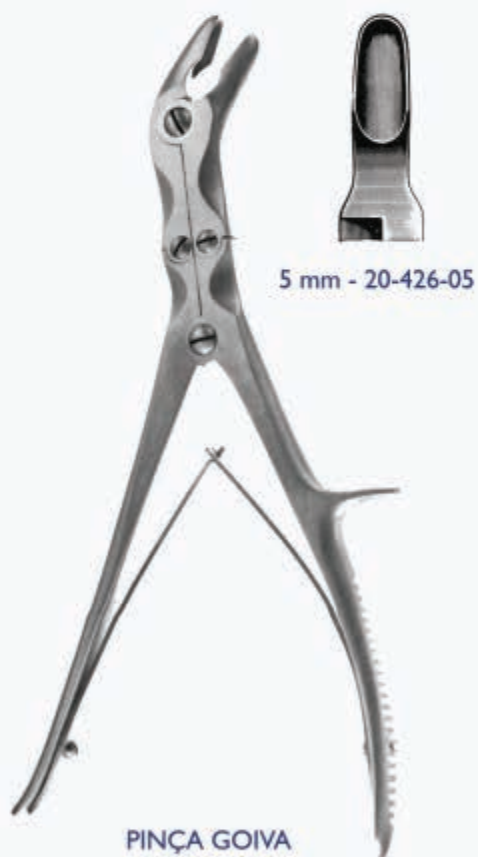

**PINÇA GOIVA
DUCK BILL 23 CM**



**PINÇA GOIVA
LEKSELL 23 CM**



14 CM
20-061-14
19 CM
20-061-19



14 CM
20-060-14
19 CM
20-060-19



CIZALHA LISTON
RETA

CIZALHA LISTON
CURVA



27 CM
35-039-27

CIZALHA
LISTON KEY



18 CM
20-073-18

CIZALHA
RUSKIN RETA

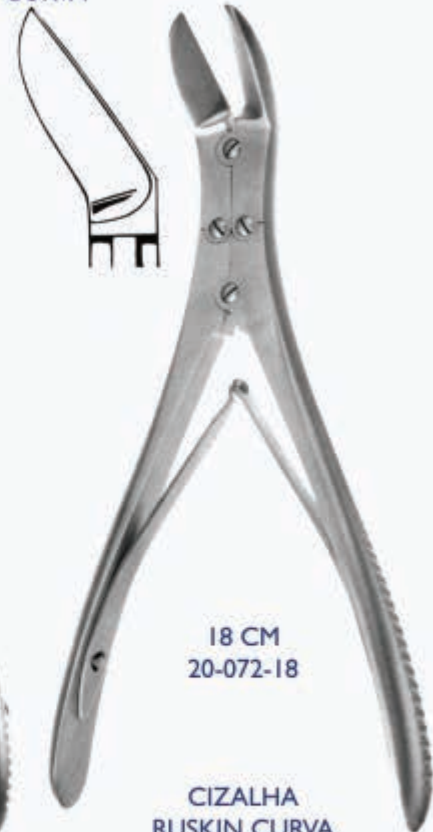

18 CM
20-072-18

CIZALHA
RUSKIN CURVA



CIZALHA
STILLE LISTON
RETA

23 CM - 20-079-23
27 CM - 20-079-27



CIZALHA
STILLE LISTON
CURVA



23 CM - 20-078-23
27 CM - 20-078-27



18 CM
20-458-18

PINÇA
LEWIN



20 CM
20-886-19

PINÇA
SEMB

21 CM - 20-438-21
26 CM - 20-438-26
31 CM - 20-438-31

PINÇA
LAMBOTTE
C/ CREMALHEIRA





26 CM
20-434-26

FARABEUF
LAMBOTTE S/ CREMALHEIRA



26 CM
20-432-26

FARABEUF
LAMBOTTE C/ CREMALHEIRA



22 CM - 20-452-22
27 CM - 20-452-27
33 CM - 20-452-33

LANE S/CREMALHEIRA



22 CM - 20-450-22
27 CM - 20-450-27
33 CM - 20-450-33

LANE C/CREMALHEIRA

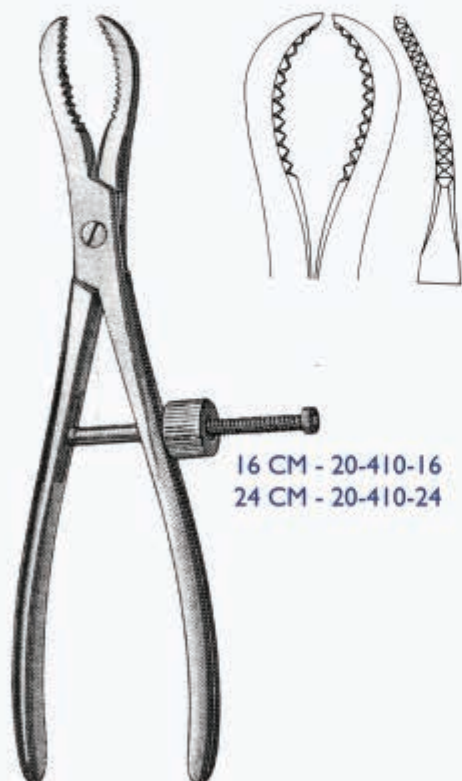

16 CM - 20-410-16
24 CM - 20-410-24

PINÇA
ESPANHOLA

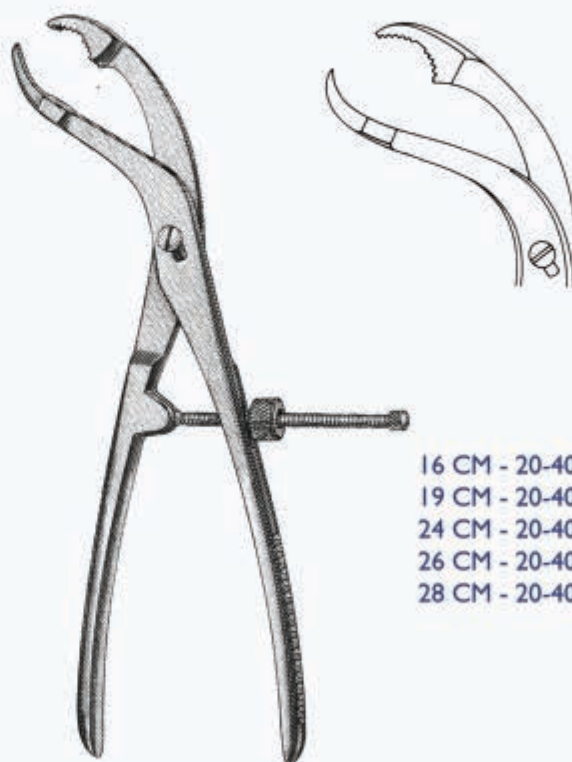

16 CM - 20-400-16
19 CM - 20-400-19
24 CM - 20-400-24
26 CM - 20-400-26
28 CM - 20-400-28

PINÇA
AUTO CENTRANTE



14 CM - 20-460-14
16 CM - 20-460-16
18 CM - 20-460-18
20 CM - 20-460-20
22 CM - 20-460-22

PINÇA LOWMANN



13 CM
20-465-13

PINÇA REDUÇÃO ÓSSEA
C/PONTA



23 CM - 20-415-23
25 CM - 20-415-25
28 CM - 20-415-28

PINÇA
ULRICH



WÍDIA
17 CM - 20-024-17W
21 CM - 20-024-21W
23 CM - 20-024-23W

ALICATE
CORTE LATERAL
DUPLA FORÇA

WÍDIA
21 CM
20-024-21W



ALICATE
CORTE LATERAL
DUPLA FORÇA



18 CM
5 mm.
20-048-05

18 CM
7 mm
20-048-07

**ALICATE P/
EXTRAÇÃO DE FIO
DE AÇO**



17 CM
20-031-17

**ALICATE PARALELO DE CORTAR
E PUXAR FIO INOX**

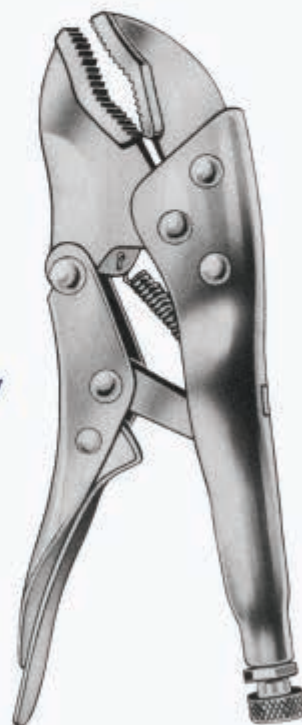

18 CM
20-028-18

**ALICATE DE
PRESSÃO INOX**



**RUGINA
FARABEU F RETA**



15 CM
20-481-16



**RUGINA
FARABEU F CURVA**



15 CM
20-480-16



ALICATE
RICARDÃO
AÇO INOX
CABO REMOVÍVEL

WÍDIA
58 CM - 20-028-58W



RUGINA
LAMBOTTE
21 CM



10 mm - 20-492-10
15 mm - 20-492-15
20 mm - 20-492-20



15 mm
20-498-01
20-499-15

RUGINA
LANGENBECK
19 CM



**RUGINA
SEMB**



N° 1
12 mm X 20,5 CM
20-600-01



N° 2
12 mm X 24 CM
20-600-02



N° 3
13 mm X 24 CM
20-600-03



N° 4
13 mm X 24 CM
20-600-04



N° 5
13 mm X 23 CM
20-600-05



N° 6
14 mm X 24 CM
20-600-06



24 CM X 43 mm
20-258-43

24 CM X 60 mm
20-258-60

BENNET



17.5 CM
20-264-18

BLOUNT



25 CM
20-266-02

BLOUNT DUPLA



27 CM
20-266-01

BLOUNT SIMPLES

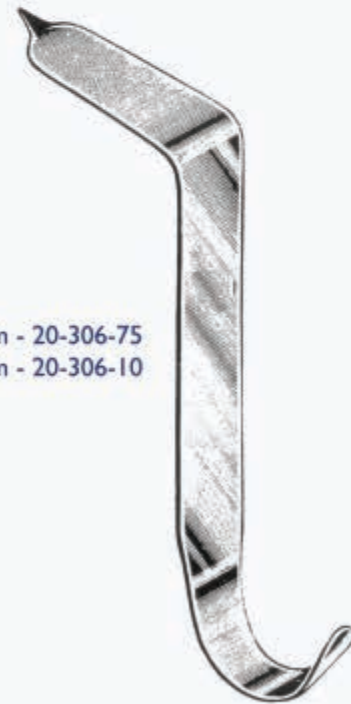

075 X 30 mm - 20-306-75
100 X 30 mm - 20-306-10

TAYLOR



RUGINA
COBB



OSTEÓTOMO
HOKE RETO

JOGO
20-490-00

14 CM
03 mm - 20-490-03
04 mm - 20-490-04
06 mm - 20-490-06
10 mm - 20-490-10
12 mm - 20-490-12



OSTEÓTOMO HIBBS RETO

JOGO
20-320-00

24 CM
06 mm - 20-320-06
12 mm - 20-320-12
16 mm - 20-320-16
18 mm - 20-320-18
22 mm - 20-320-22
25 mm - 20-320-25
32 mm - 20-320-32



OSTEÓTOMO HIBBS CURVO

JOGO
20-321-00

24 CM
06 mm - 20-321-06
12 mm - 20-321-12
16 mm - 20-321-16
18 mm - 20-321-18
22 mm - 20-321-22
25 mm - 20-321-25
32 mm - 20-321-32



**LAMBOTE
23 CM**

06 mm - 20-331-06
10 mm - 20-331-10
15 mm - 20-331-15
20 mm - 20-331-20
25 mm - 20-331-25
30 mm - 20-331-30

**MINI LAMBOTE
17CM**

06 mm - 20-333-06
10 mm - 20-333-10
15 mm - 20-333-15
20 mm - 20-333-20
25 mm - 20-333-25
30 mm - 20-333-30

**OSTEÓTOMO
LAMBOTTE
RETO**



**LAMBOTE
23 CM**

06 mm - 20-330-06
10 mm - 20-330-10
15 mm - 20-330-15
20 mm - 20-330-20
25 mm - 20-330-25
30 mm - 20-330-30

**MINI LAMBOTE
17CM**

06 mm - 20-332-06
10 mm - 20-332-10
15 mm - 20-332-15
20 mm - 20-332-20
25 mm - 20-332-25
30 mm - 20-332-30

**OSTEÓTOMO
LAMBOTTE
CURVO**



**LAMBOTE
23 CM**

06 mm - 20-073-06
09 mm - 20-073-09
12 mm - 20-073-12
15 mm - 20-073-15
20 mm - 20-073-20
25 mm - 20-073-25
30 mm - 20-073-30

**OSTEÓTOMO
SMITH PETERSEN**



20 CM
08 mm - 20-354-08
10 mm - 20-354-10
12 mm - 20-354-12
15 mm - 20-354-15
20 mm - 20-354-20
25 mm - 20-354-25



20 CM
08 mm - 20-355-08
10 mm - 20-355-10
12 mm - 20-355-12
15 mm - 20-355-15
18 mm - 20-355-18
22 mm - 20-355-22

OSTEÓTOMO
STILLE DUPLO
BIZEL

STILLE GOIVA

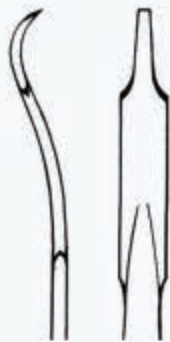

16 CM
6 mm - 20-300-00

ELEVADOR
MINI HOHMANN



16 CM
8 mm - 20-302-00

ELEVADOR
MINI HOHMANN



24 CM
08 mm - 20-300-01
PONTA FINA

ELEVADOR
HOHMANN



24 CM
18 mm - 20-300-02
PONTA FINA

ELEVADOR
HOHMANN



24 CM
33 mm - 20-300-02
PONTA CHATA

ELEVADOR
HOHMANN



24 CM
70 mm - 20-300-06
PONTA FINA

ELEVADOR
HOHMANN



24 CM
43 mm - 20-300-05
PONTA FINA

ELEVADOR
HOHMANN



24 CM
22 mm - 20-300-03
PONTA CHATA

ELEVADOR
HOHMANN



CURETA
BRUNS
17 CM



N° 000
20-180-30



N° 00
20-180-20



N° 0
20-180-10



N° 1
20-180-01



N° 2
20-180-02



N° 3
20-180-03



N° 4
20-180-04



N° 5
20-180-05



N° 6
20-180-06



CURETA VOLKMANN
17 CM



N° 0000
20-151-40



N° 000
020-151-30



N° 00
020-151-20



N° 0
020-151-10



N° 1
020-151-01



N° 2
020-151-02



N° 3
020-151-03



N° 4
020-151-04



N° 5
020-151-05



N° 6
020-151-06



CURETA
SIMON
23 CM



CURETA
SPRATT
18 CM





320G
20-372-32

MARTELO MEAD C/CABEÇAS
INTERCAMBIÁVEIS



350G - 20-380-35
500G - 20-380-50
750G - 20-380-75
1000G - 20-380-10

MARTELO UNIVERSAL



120G - 20-384-12
320G - 20-384-32

MARTELO
VICKERS EXTREMIDADES
EM NYLON



250G
20-378-25

MARTELO
PARTSCH



AFASTADOR FUKUDA
35 mm - 20-510-00
40 mm - 20-510-01



AFASTADOR GLENÓIDE
LARGO - 20-511-20
ESTREITO - 20-511-10



20-300-10

**AFASTADOR
BENT-HOMANN**
90°

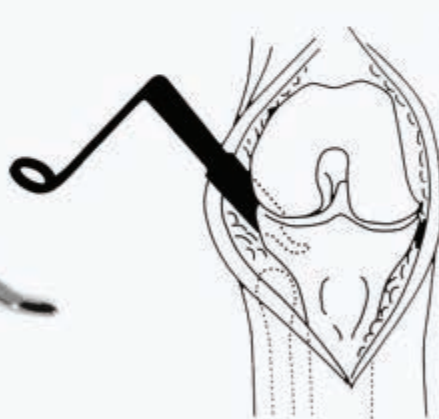



ADULTO
20-110-01

INFANTIL
20-111-01

ESTRIBO DE
BOEHLER



20-500-00

EXTRATOR DE CABEÇA
DE FÊMUR

Set emergencial para retirada de parafusos danificados ou quebrados nos ossos.

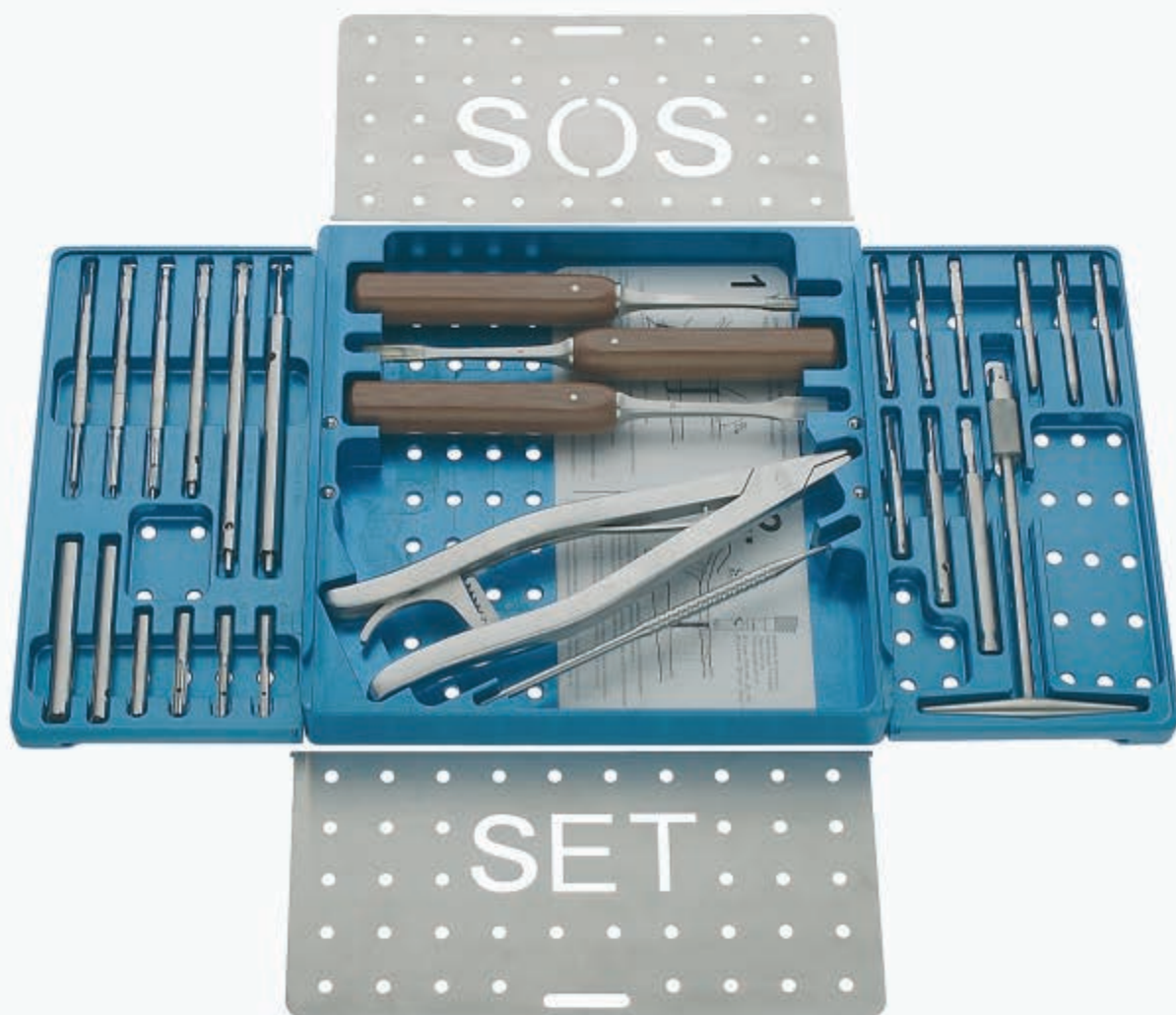

Acompanha dois templates de Alumínio com instruções para remover parafusos quebrados ou danificados.



SET DE REMOÇÃO
COMPLETO

20-900-00

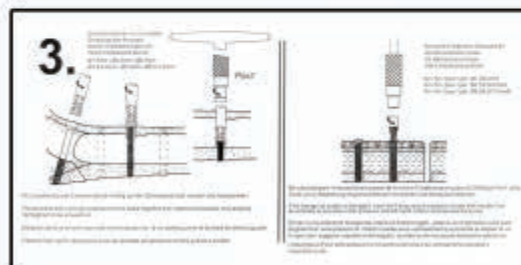
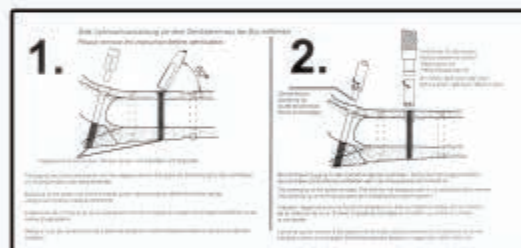

CONTAINER

CONTAINER PERFURADO
COM FECHO PARA AUTOCLAVE

280 X 280 X 150MM - HE-1130-10

480 X 280 X 150MM - HE-1130-13

580 X 280 X 150MM - HE-1130-15



1,5 mm - 20-360-15
2,0 mm - 20-360-20
2,7 mm - 20-360-27
3,5 mm - 20-360-35
4,0 mm - 20-360-40
4,5 mm - 20-360-45
5,0 mm - 20-360-50
6,5 mm - 20-360-65
7,0 mm - 20-360-70

TREFINA OCA
COMPLETA



1,5 mm - 20-100-15
2,0 mm - 20-100-20
2,7 mm - 20-100-27
3,5 mm - 20-100-35
4,0 mm - 20-100-40
4,5 mm - 20-100-45
5,0 mm - 20-100-50
6,5 mm - 20-100-65
7,0 mm - 20-100-70

EXTRATOR DE PARAFUSO
QUEBRADO



160 mm
20-123-10

CABO LANG EMT



10 mm
20-000-10

GOIVA CÔNCAVA



6 mm
20-000-06

GOIVA CÔNCAVA



4 mm
20-000-04

GOIVA CÔNCAVA



20-111-30
GANCHO/ERINA
LANG



1,5 mm - 20-361-15
2,0 mm - 20-361-20
2,7 mm - 20-361-27
3,5 mm - 20-361-35
4,0 mm - 20-361-40
4,5 mm - 20-361-45
5,0 mm - 20-361-50
6,5 mm - 20-361-65
7,0 mm - 20-361-70

TREFINA OCA
DE REPOSIÇÃO



1,5 e 2,0 mm - 20-121-15
2,7 - 3,5 e 4,0 mm - 20-121-27
4,5 e 6,5 mm - 20-121-45

PARAFUSOS DE
EXTRAÇÃO CÔNICO



1,5 mm - 20-365-15
2,0 mm - 20-365-20
2,7 mm - 20-365-27
3,5 mm - 20-365-35
4,0 mm - 20-365-40
4,5 mm - 20-365-45
5,0 mm - 20-365-50
6,5 mm - 20-365-65
7,0 mm - 20-365-70

TREFINA PARA
CENTRALIZAÇÃO
DE PARAFUSO



20,5 CM
20-121-20

CIZALHA
ARTICULADA

30

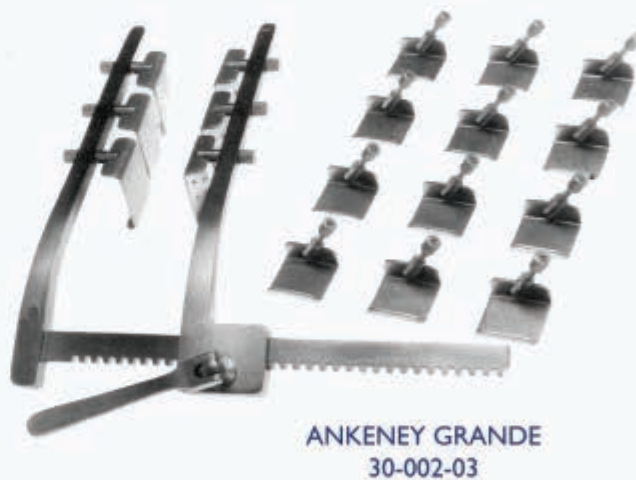

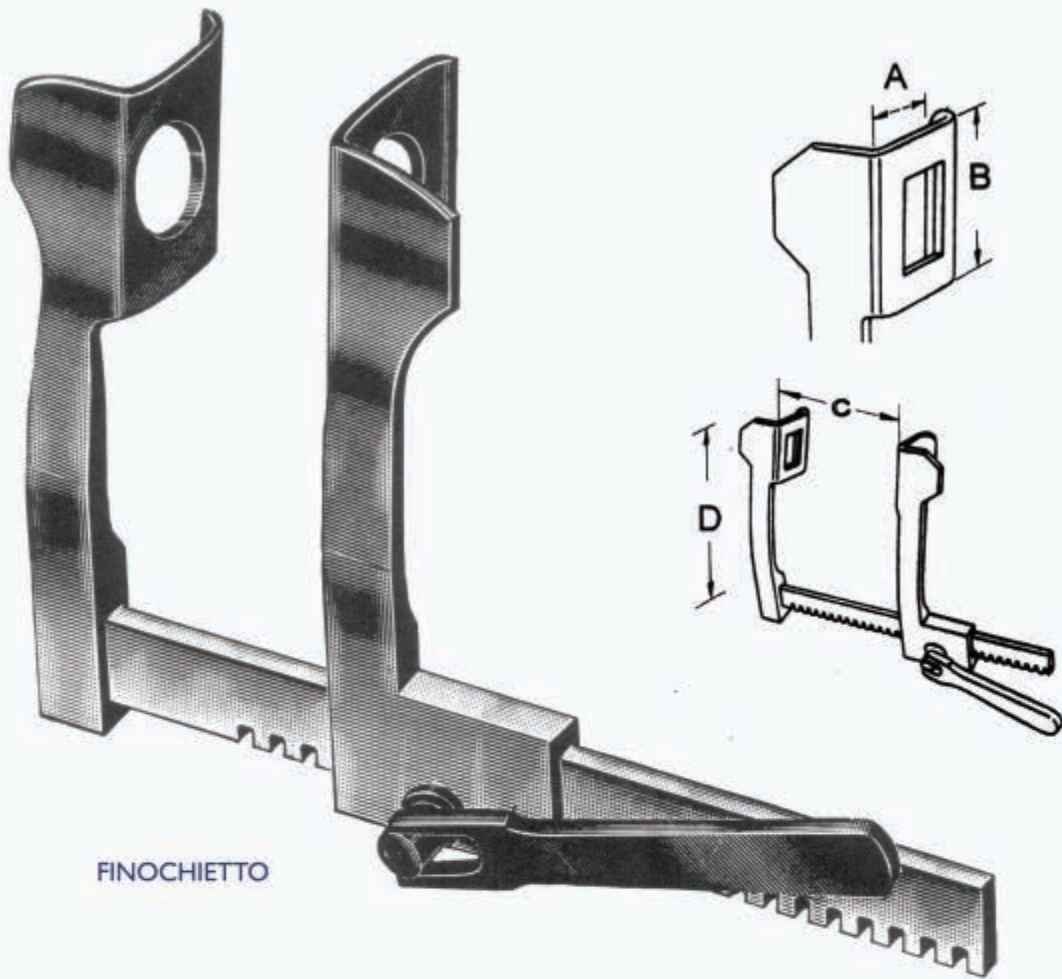

FINOCHIETTO

	A	B	C	D	CÓDIGO
NEO NATAL	10 mm	15 mm	75 mm	60 mm	30-006-01
BABY	21 mm	30 mm	30 mm	85 mm	30-006-02
INFANTIL	30 mm	55 mm	55 mm	115 mm	30-006-03
ADULTO	45 mm	65 mm	65 mm	185 mm	30-006-04

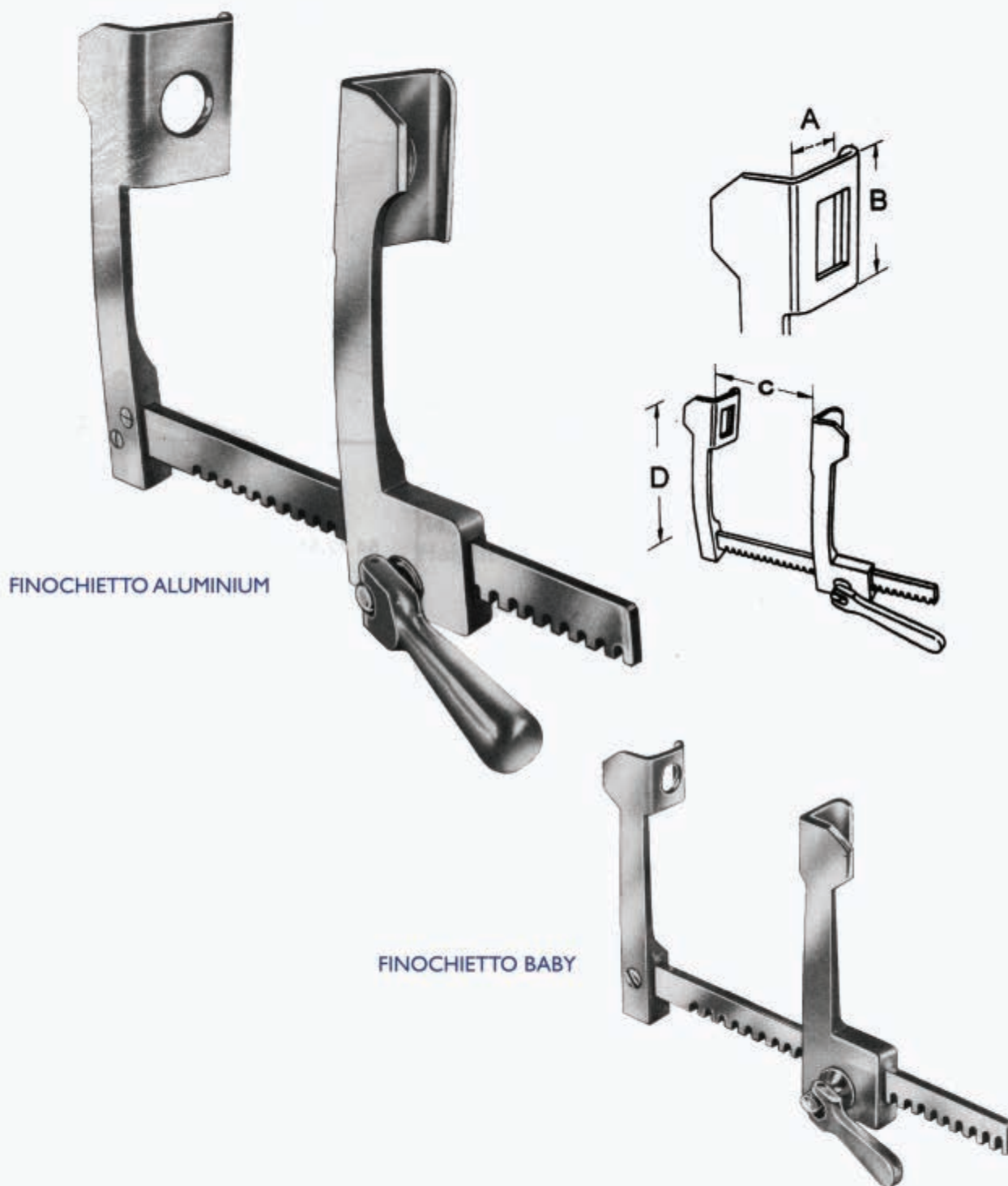

	A	B	C	D	CÓDIGO
NEO NATAL	10 mm	15 mm	75 mm	60 mm	30-006-01A
BABY	25 mm	30 mm	100 mm	85 mm	30-006-02A
INFANTIL	30 mm	55 mm	160 mm	115 mm	30-006-03A
ADULTO	45 mm	65 mm	175 mm	185 mm	30-006-04A



COOLEY ATRIAL

ESQUERDO
30-003-02



COOLEY ATRIAL

DIREITO
30-003-01



HENLEY

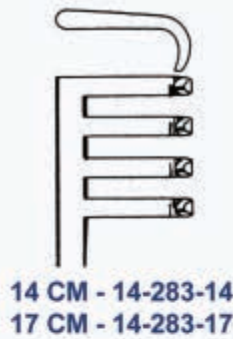

14 CM - 14-283-14
17 CM - 14-283-17



14 CM - 14-282-14
17 CM - 14-282-17



16 x 19 mm
16 x 25 mm
16 x 32 mm



N° 1 - 12X200mm
14-300-12

N° 2 - 14X200mm
14-300-14

N° 3 - 16X200mm
14-300-16

N° 4 - 18X200mm
14-300-18

KIRKLIN

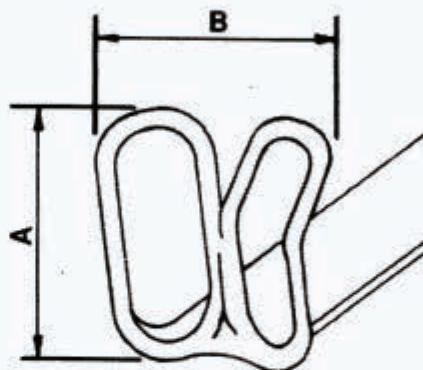

A	B	CÓDIGO
24 mm	21 mm	30-008-24
28 mm	21 mm	30-008-28
37 mm	27 mm	30-008-37

DINKHUYSEN
P/AORTA



14 CM - 20-036-14
18 CM - 20-036-18

BAILEY



VALVULA MITRAL
30-008-01



16 CM - 14-240-16
18 CM - 14-240-18

GELPI

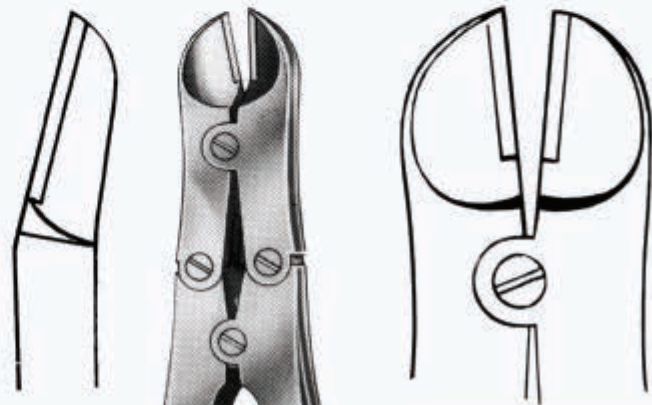

WIDIA

17 CM - 20-024-17W
21 CM - 20-024-21W
23 CM - 20-024-23W

AGUDO
14 CM - 14-570-14
16 CM - 14-570-16
18 CM - 14-570-18

ROMBO
14 CM - 14-571-14
16 CM - 14-571-16
18 CM - 14-571-18



WEITLANER



ALICATE
CORTE LATERAL
DUPLA FORÇA



GLUCK

19 CM - 20-102-19
22 CM - 20-102-22



STANDART

22 CM - 20-120-22



UNIVERSAL

350G - 20-380-35
500G - 20-380-50
750G - 20-380-75
1000G - 20-380-10



FACA LEBSCHÉ

25 CM
30-660-25



07 CM - 30-013-07
08 CM - 30-013-08
10 CM - 30-013-10
12 CM - 30-013-12

**BULLDOG
DEBAKEY RETO**



07 CM - 30-014-07
08 CM - 30-014-08
10 CM - 30-014-10
12 CM - 30-014-12

**BULLDOG
DEBAKEY CURVO**

3,5 CM - 30-015-35
5,0 CM - 30-015-50



**BULLDOG
DIEFFENBACH
RETO**

3,5 CM - 30-016-35
5,0 CM - 30-016-50



**BULLDOG
DIEFFENBACH
CURVO**



08mm
CURVO
4,5 CM - 30-018-08
RETO
5,0 CM - 30-017-08

**BULLDOG
DIETRICH**



12mm
CURVO
4,7 CM - 30-018-12
RETO
5,2 CM - 30-017-12

**BULLDOG
DIETRICH**



**PINÇA APLICADORA
DE BULLDOGS**

23 CM
30-110-23



1,2 X 0,6 mm
30-690-12

1,8 X 1,0 mm
30-690-18

2,5 X 1,5 mm
30-690-25

DENNIS



30-692-18



24 CM - 30-702-24

TITANIUM
30-702-20T

DINKHUYSEN
P/ MAMARIA



DEBAKEY



1,5 mm
15 CM - 30-715-15
20 CM - 30-720-15
24 CM - 30-724-15

TITANIUM
1,5 mm
15 CM - 30-715-15T
20 CM - 30-720-15T
24 CM - 30-724-15T

1,8 mm
15 CM - 30-715-18T
20 CM - 30-720-18T
24 CM - 30-724-18T



DEBAKEY



2,0 mm
15 CM - 30-715-20
20 CM - 30-720-20
24 CM - 30-724-20
30 CM - 30-730-20

TITANIUM
2,0 mm
24 CM - 30-724-20T



DEBAKEY



2,5 mm
20 CM - 30-720-25
24 CM - 30-724-25
30 CM - 30-730-25

TITANIUM
2,5 mm
20 CM - 30-720-25T

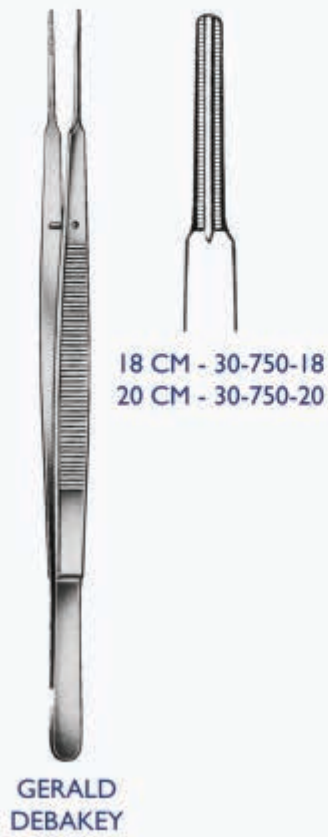



JAVID
18 CM

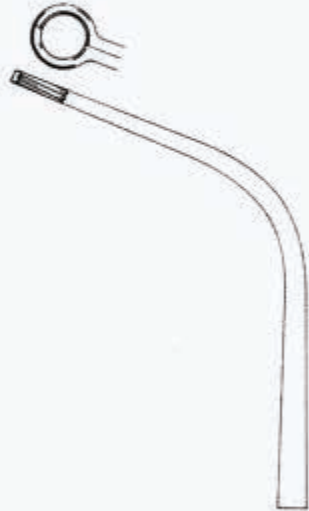

4 mm - 30-600-04
6 mm - 30-600-06
8 mm - 30-600-08



GLOVER
16 CM

CURVO
30-030-16

RETO
30-031-16

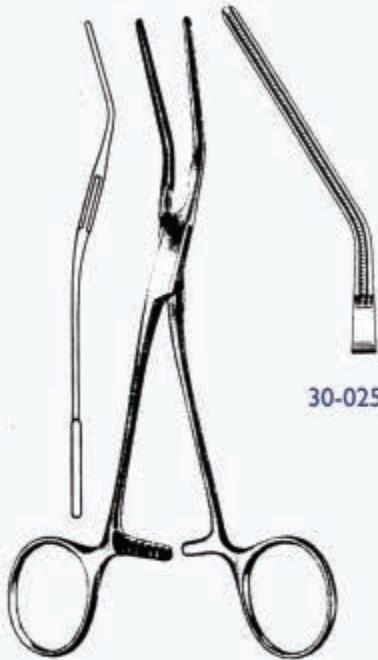

DEBAKEY
17 CM

30-025-17



DEBAKEY
16 CM

30-025-16



DEBAKEY
16 CM

30-026-16



DEBAKEY
13 CM



45 mm
30-020-12

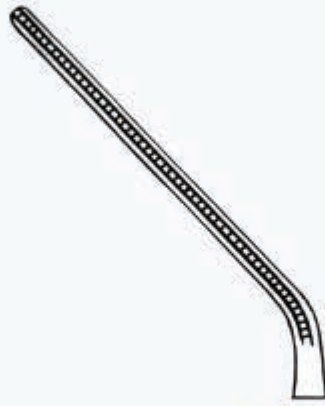

40 mm - 45°
30-023-11



40 mm - 90°
30-024-10



DeBakey com serrilhas
atraumaticas



DEBAKEY
13 CM



45 mm
30-021-11



DEBAKEY
13 CM



45 mm
30-022-11



DEBAKEY
DERRA



13 CM - 30-060-13
16 CM - 30-060-16
17 CM - 30-060-17
18 CM - 30-060-18

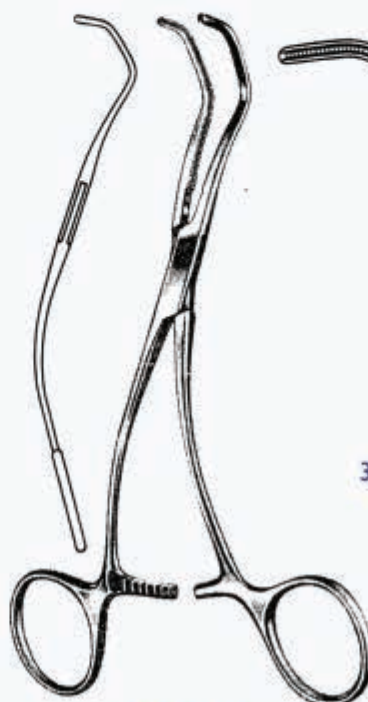

DEBAKEY



17 CM
30-066-17



DEBAKEY
GREGORY



14 CM
30-077-14



14 CM
30-079-14



DEBAKEY



19 CM - 30-084-19
20 CM - 30-084-20

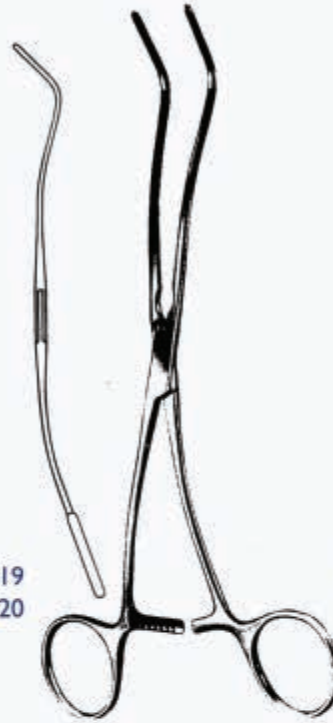

DEBAKEY



20 CM
30-090-20



DEBAKEY
LELAND-JONES



18 CM
30-096-18



19 CM
30-096-19



20 CM
30-096-20





19 CM
30-102-19

20 CM
30-102-20

POTTS



19 CM
30-104-19

20 CM
30-104-20

POTTS

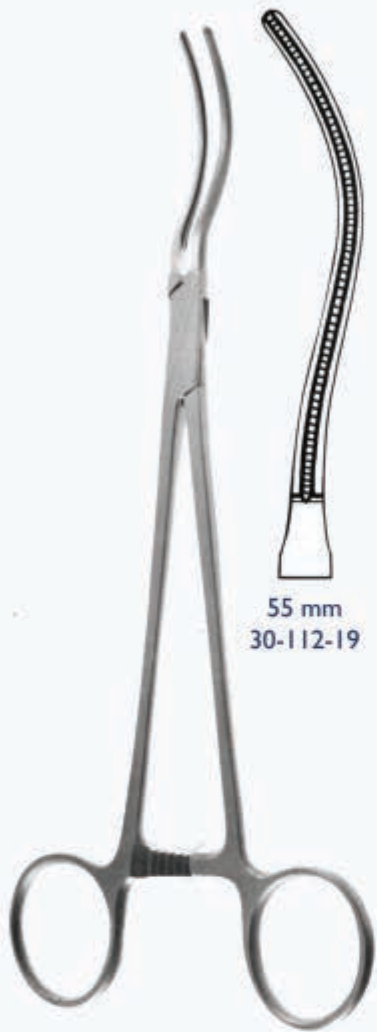

55 mm
30-112-19

POTTS DEBAKEY
19 CM



55 mm
30-112-20

POTTS DEBAKEY
20 CM



DeBakey com serrilhas
atraumaticas



DEBAKEY

18 CM - 30-180-18
20 CM - 30-180-20
27 CM - 30-180-27
31 CM - 30-180-31



DEBAKEY



16 CM - 30-192-16
17 CM - 30-192-17



DEBAKEY
LAMBERT-KAY



22 CM
30-216-22



21 CM
30-216-21



DeBakey com serrilhas
atraumaticas



18 CM
30-222-18

DEBAKEY
BECK

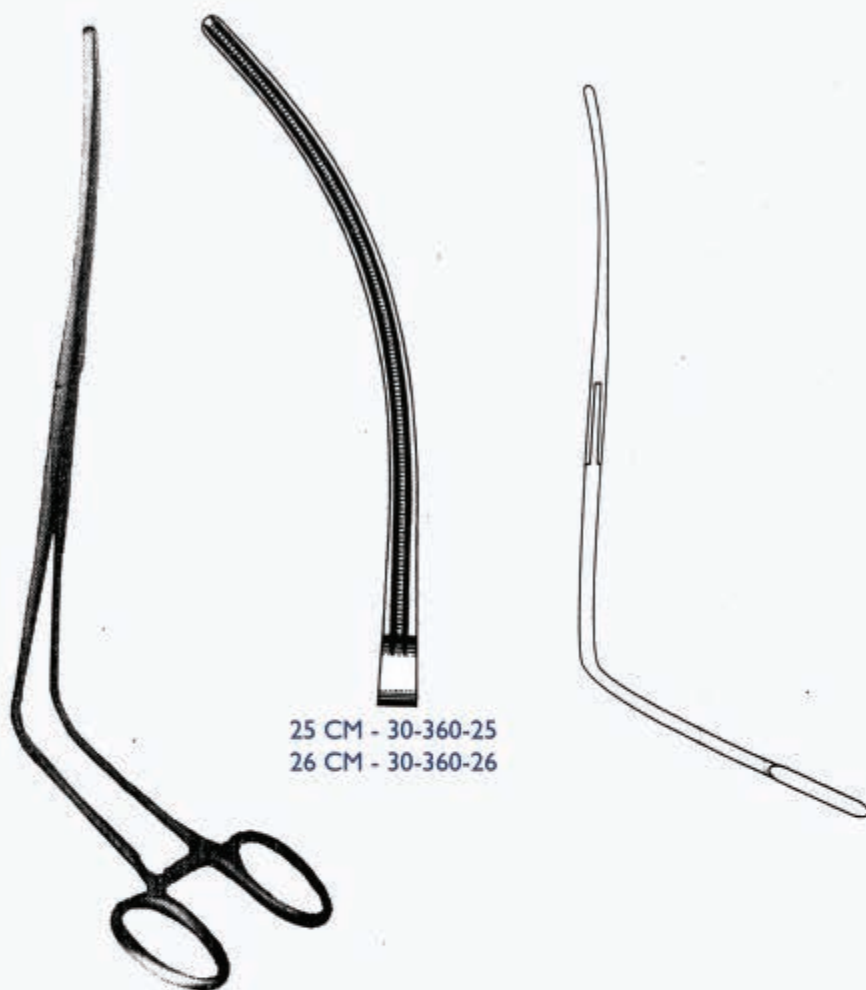

25 CM - 30-360-25
26 CM - 30-360-26

DEBAKEY
MATOX



DeBakey com serrilhas
atraumaticas



DEBAKEY
60°

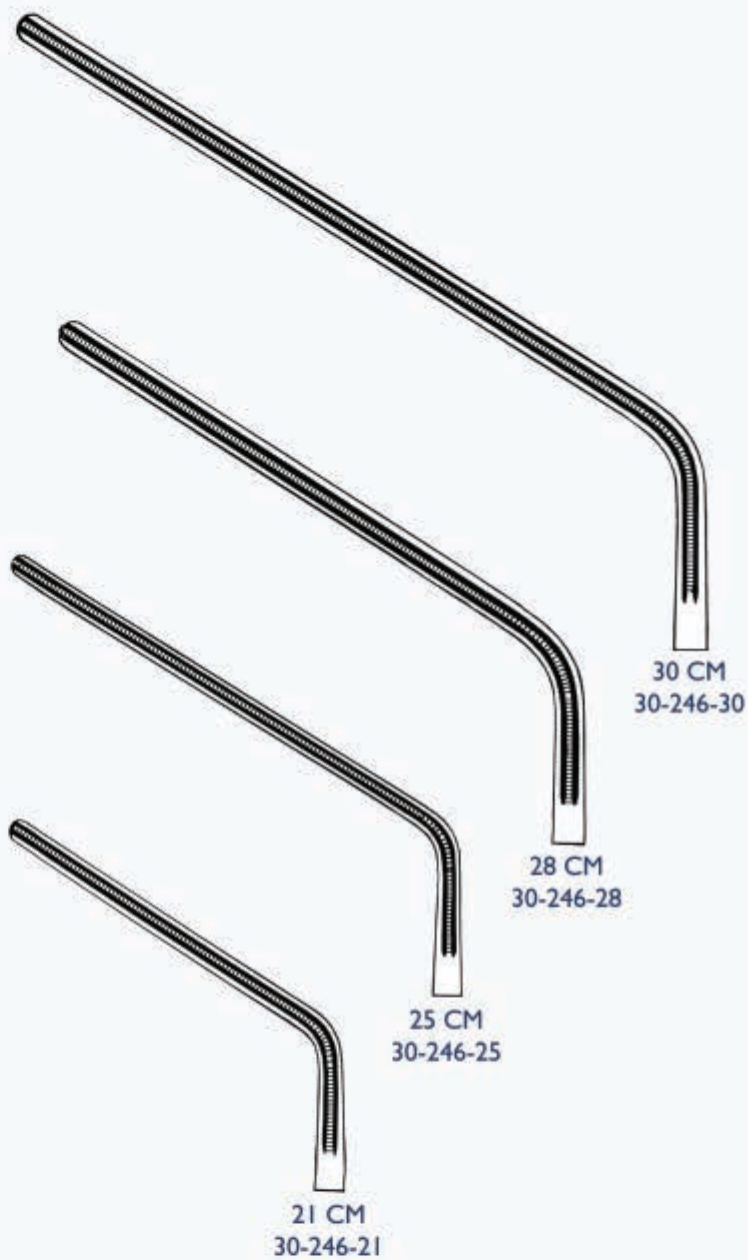

DeBakey com serrilhas
atraumaticas



DeBakey com serrilhas
atraumaticas



5 CM - 3 mm
30-010-03

AGULHA C/PONTA
P/HEPARINA



8 mm



10 mm



DESCOLADOR
DE PLACA



DESCOLADOR
DE PLACA



DESCOLADOR
FINO

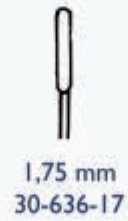



25 CM TOTAL
TUBO 18 CM

30°
30-150-30

CÂNULA
DINKHUYSEN
25 CM



25 CM TOTAL
TUBO 18 CM

90°
30-150-90

CÂNULA
DINKHUYSEN
25 CM



30-666-20

GANCHO
P/SIMPATECTOMIA



30-668-00

PASSA FIO
DE RUMEL



PINÇA
LONGUETTE



23 CM - 13-462-23

DELICADA
23 CM - 13-464-23

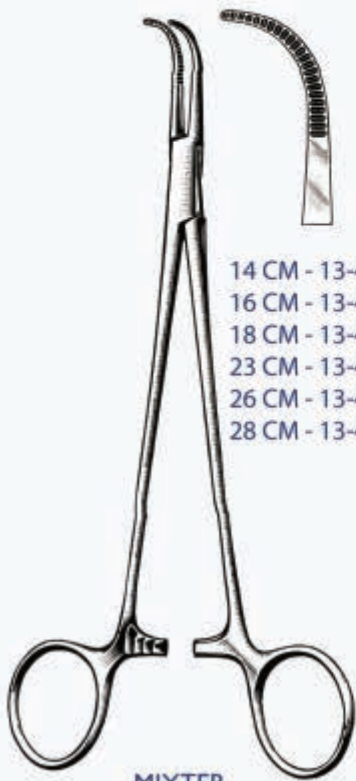

14 CM - 13-480-14
16 CM - 13-480-16
18 CM - 13-480-18
23 CM - 13-480-23
26 CM - 13-480-26
28 CM - 13-480-28

MIXTER



17 CM - 13-408-17
20 CM - 13-408-20

GEMINI



21 CM - 13-503-21
24 CM - 13-503-24

MOYNIHAN



19 CM - 52-388-19
21 CM - 52-388-21

SCHNIDT CURVA



30-762-24

24 CM
ORDENHA



34 CM
30-010-00

PINÇA
P/VÁLVULA MITRAL



9 CM
30-770-09

PENTEAN
C/CREMALHEIRA



9 CM
30-772-09

PENTEAN
S/CREMALHEIRA



30-782-18



30-780-18
18 CM
REYNOLD P/TUBOS
SERRILHADA



SACA TROMBO



SEMB CURVA



PORTA AGULHA
PI FIO DE AÇO C/WÍDIA



PORTA AGULHA
MAYO HEGAR
C/WÍDIA

12 CM - 17-012-12W
14 CM - 17-012-14W
16 CM - 17-012-16W
18 CM - 17-012-18W
20 CM - 17-012-20W
23 CM - 17-012-23W
25 CM - 17-012-25W
30 CM - 17-012-30W



PORTA AGULHA
DEBAKEY C/WÍDIA

18 CM - 17-021-18W
20 CM - 17-021-20W
23 CM - 17-021-23W
25 CM - 17-021-25W
30 CM - 17-021-30W



1mm

14 CM - 17-181-14W
16 CM - 17-181-16W
18 CM - 17-181-18W
20 CM - 17-181-20W
25 CM - 17-181-25W

RYDER C/WÍDIA



2mm

14 CM - 17-182-14W
16 CM - 17-182-16W
18 CM - 17-182-18W
20 CM - 17-182-20W
25 CM - 17-182-25W

RYDER C/WÍDIA



18 CM - 17-016-18W
20 CM - 17-016-20W
23 CM - 17-016-23W
25 CM - 17-016-25W
30 CM - 17-016-30W

VASCULAR C/WÍDIA



TITANIUM
18 CM - 17-030-18T
21 CM - 17-030-21T
23 CM - 17-030-23T

BARRAQUER
COM TRAVA C/WÍDIA



TITANIUM
18CM - 17-032-18T
21CM - 17-032-21T
23CM - 17-032-23T

BARRAQUER
SEM TRAVA C/WÍDIA



14 CM - 17-060-14W
18 CM - 17-060-18W
20 CM - 17-060-20W

CASTROVIEJO
COM TRAVA C/WÍDIA



25 CM
17-072-25W

FINOCHIETTO C/WÍDIA



WÍDIA
18 CM - 11-038-18W

BOYD CURVA EM S
VASCULAR



25°
11-420-25

WÍDEA
11-420-25W



45°
11-420-45

WÍDEA
11-420-45W



60°
11-420-60

WÍDEA
11-420-60W



90°
11-420-90

WÍDEA
11-420-90W

DIETRICH 18 CM

125°
11-420-12





POTTS SMITH



25°
18 CM - 11-360-25

WIDEA
18 CM - 11-360-25W



45°
18 CM - 11-360-45

WIDEA
18 CM - 11-360-45W



60°
18 CM - 11-360-60

WIDEA
18 CM - 11-360-60W



METZENBAUM
VASCULAR CURVA

WIDEA

18 CM - 11-306-18W

20 CM - 11-306-20W

23 CM - 11-306-23W

25 CM - 11-306-25W

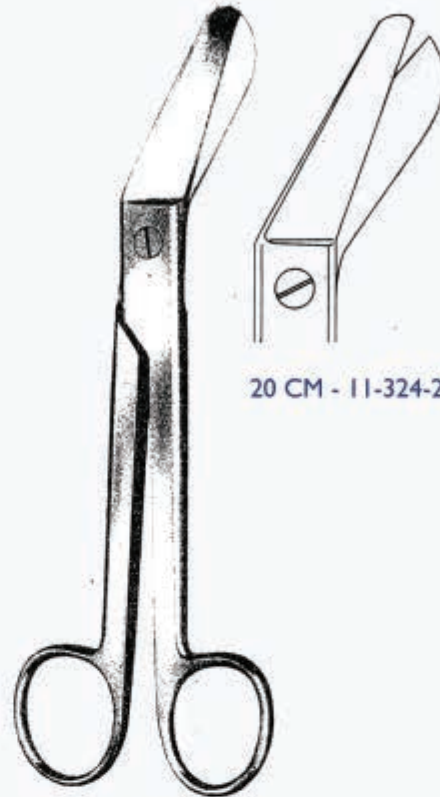

20 CM - 11-324-20S

TESOURA P/CORTAR
TUBOS SERRILHADA

35



32 CM - 7 X 7
14-048-32 AGUDO
14-049-32 ROMBO

ADSON BECKMANN
EATON



17 CM - 4 X 3
14-041-17 AGUDO
14-042-17 ROMBO

ADSON BECKMANN



31 CM - 4 X 4
14-041-31 AGUDO
14-042-31 ROMBO

ADSON BECKMANN



31 CM
14-012-31 AGUDO
14-013-31 ROMBO

ADSON



25 CM - 35-008-25

CLOWARD

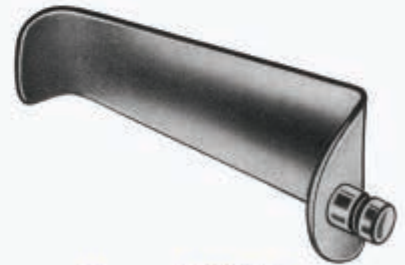

45 mm - 35-086-45
50 mm - 35-086-50
55 mm - 35-086-55
60 mm - 35-086-60



45 mm - 35-085-45
50 mm - 35-085-50
55 mm - 35-085-55
60 mm - 35-085-60

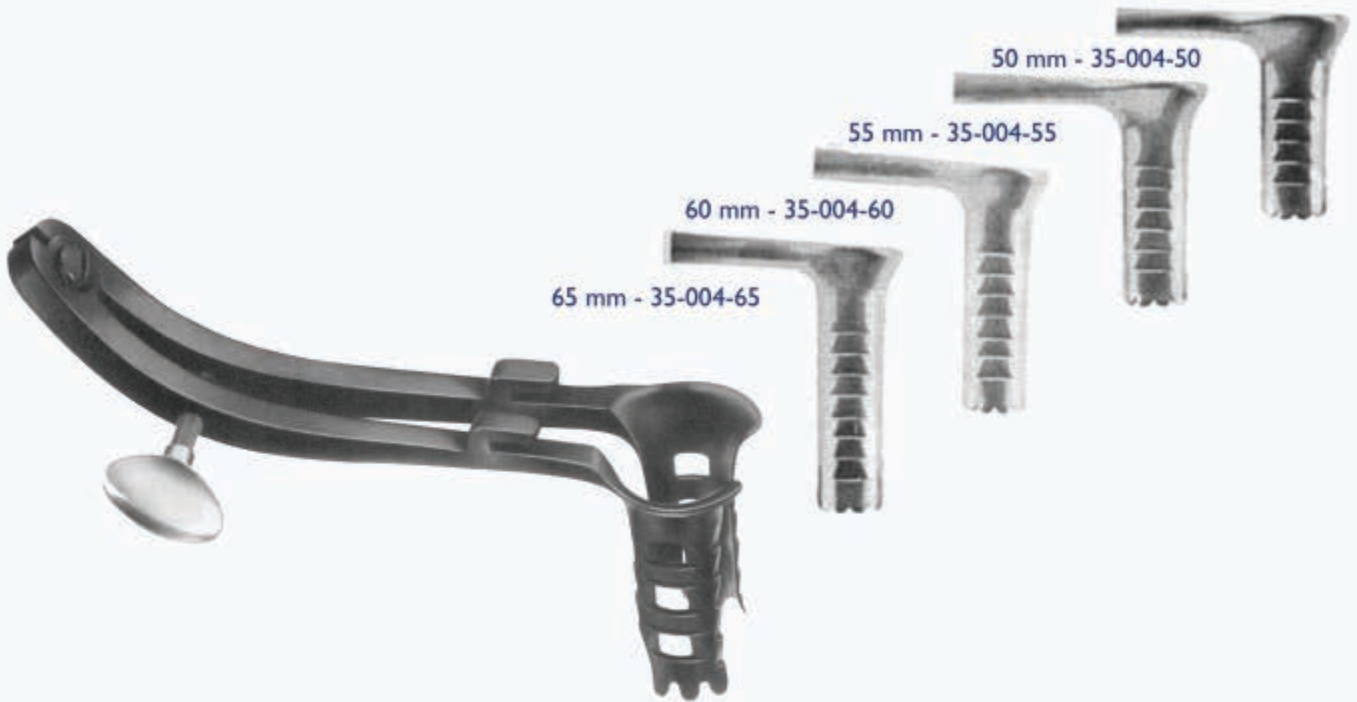

CASPAR



23 CM
35-009-23

CLOWARD LOMBAR
POSTERIOR

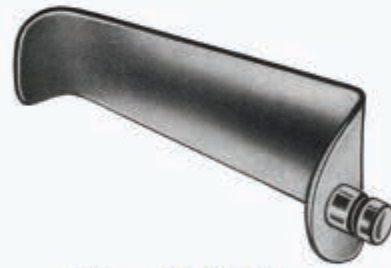

45 mm - 35-086-45
50 mm - 35-086-50
55 mm - 35-086-55
60 mm - 35-086-60



45 mm - 35-085-45
50 mm - 35-085-50
55 mm - 35-085-55
60 mm - 35-085-60



35-010-13

CLOWARD P/VIA ANTERIOR

12 mm - 35-013-12
14 mm - 35-013-14
16 mm - 35-013-16



PARAFUSO



DRILL

35-012-02



16 CM
35-012-16D - DIREITO
35-012-16E - ESQUERDO

CASPAR
CORPO VERTEBRAL



35-012-01

CHAVE APLICADORA



DIREITO
35-012-03D

GUIA DO DRILL



ESQUERDO
35-012-03E

GUIA DO DRILL



35-012-04

APLICADOR DE ENXERTO

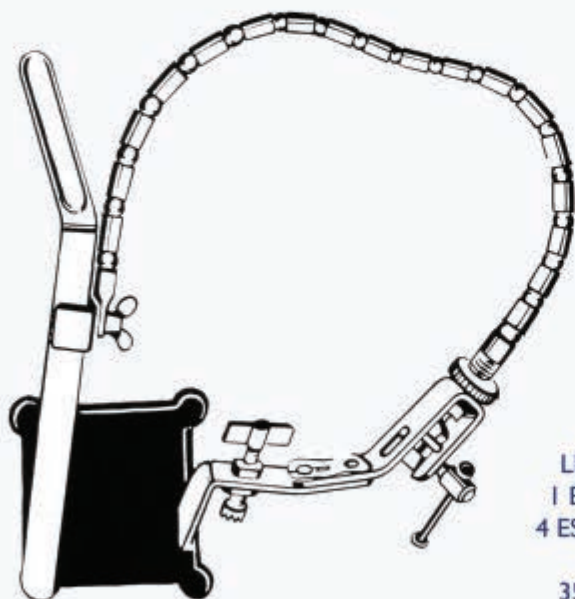

LEYLA C/
1 BRAÇO E
4 ESPÁTULAS

35-016-01

Utilização do Afastador

Demonstração da utilização do
afastador Leyla com 1 braço



Demonstração da utilização do
afastador Leyla com 2 braços

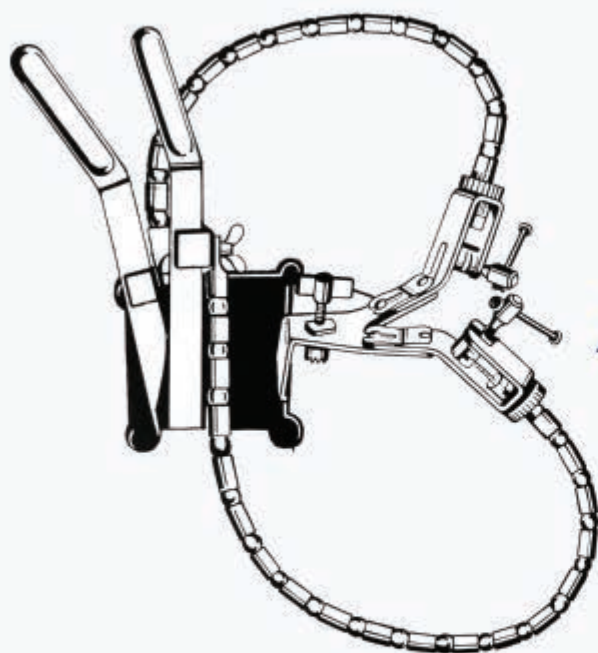

LEYLA C/
2 BRAÇO E
4 ESPÁTULAS

35-016-02



Acessórios para montagem do afastador Leyla na mesa.

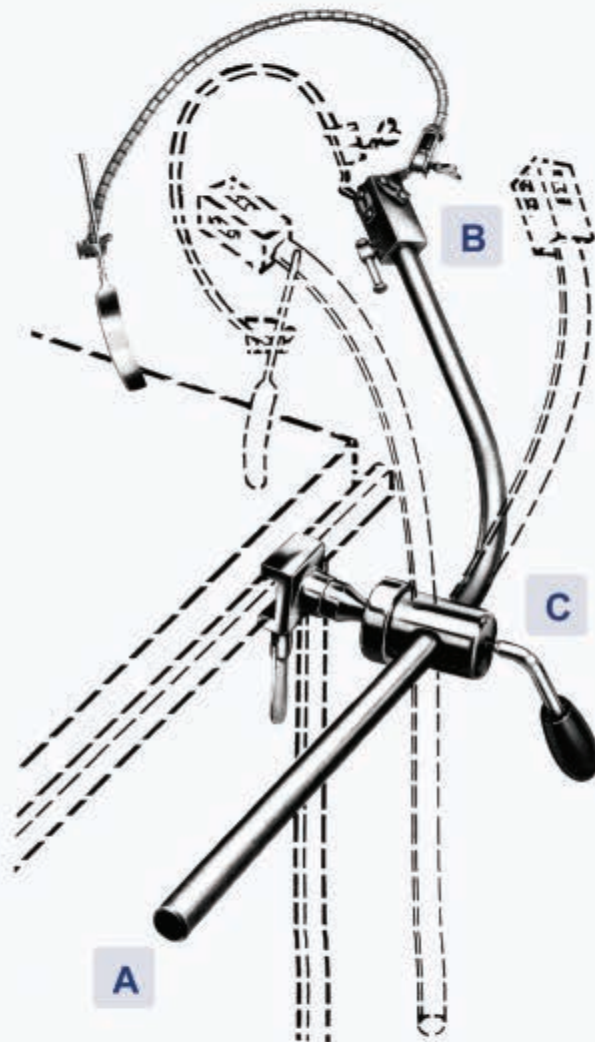

- A** Rígida fixação do braço.
- B** Cabeça aclopável para segurar até cinco braços flexíveis.
- C** Clamp para montagem, permitindo que o braço se mantenha rígido ao lado da mesa de operações.

35-074-00

HASTE YASAGIL
P/ AFASTADOR LEYLA

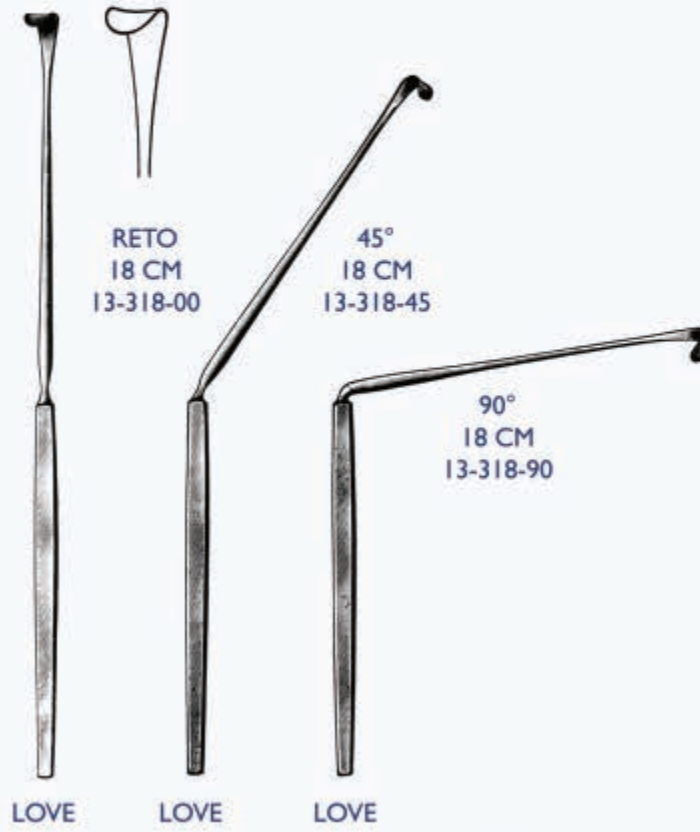

LADO ESQUERDO

17 CM
14-321-17



LADO DIREITO

17 CM
14-320-17

MARKHAN MEYERDING

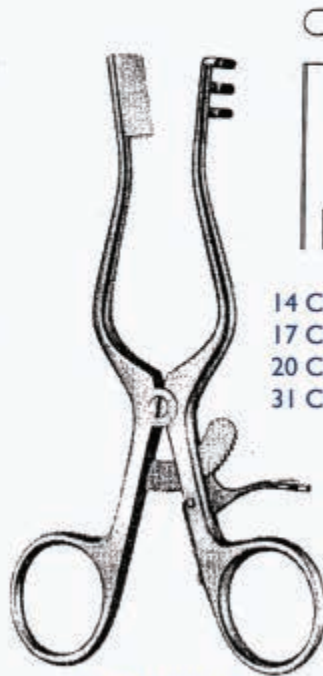

14 CM - 14-375-14
17 CM - 14-375-17
20 CM - 14-375-20
31 CM - 14-375-31

MEYERDING
ESQUERDO

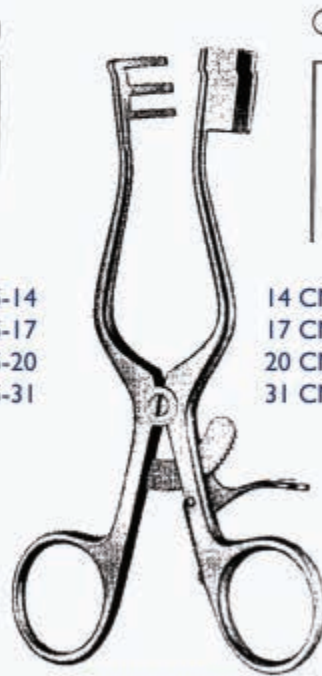

14 CM - 14-374-14
17 CM - 14-374-17
20 CM - 14-374-20
31 CM - 14-374-31

MEYERDING
DIREITO



17 CM - 14-362-17
31 CM - 14-362-31

MEYERDING
ESQUERDO



17 CM - 14-361-17
31 CM - 14-361-31

MEYERDING
DIREITO

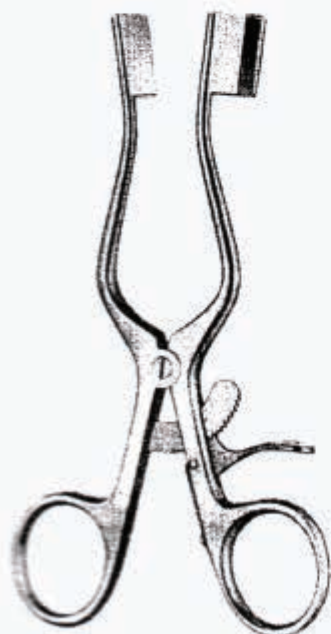

14 CM - 14-368-14
17 CM - 14-368-17
20 CM - 14-368-20
31 CM - 14-368-31

MEYERDING
DUPLO



17 CM - 14-360-17
31 CM - 14-360-31

MEYERDING
DUPLO ARTICULADO



AGUDO
14 CM - 14-420-14
16 CM - 14-420-16

ROMBO
14 CM - 14-421-14
16 CM - 14-421-16

SCALP

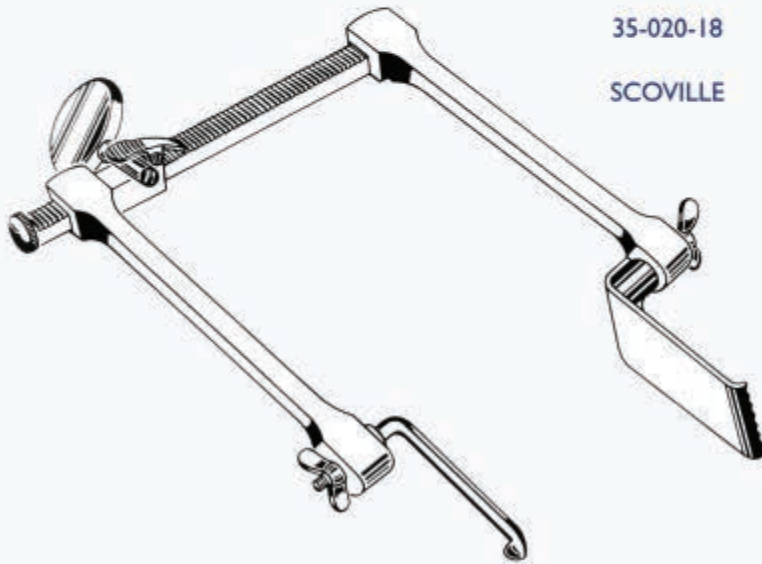

35-020-18

SCOVILLE



35-083-38

35-083-44



35-021-18

SCOVILLE
HAVERFIELD

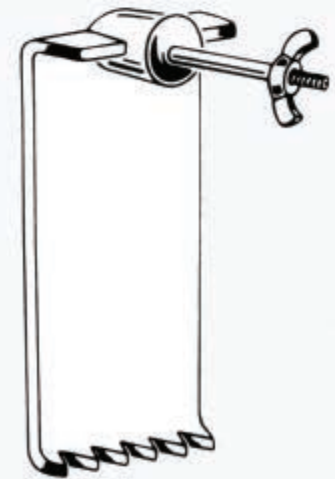

35-081-50

35-081-70

35-081-80



35-080-20

35-080-25

35-080-35

35-080-45

35-080-55

35-080-75

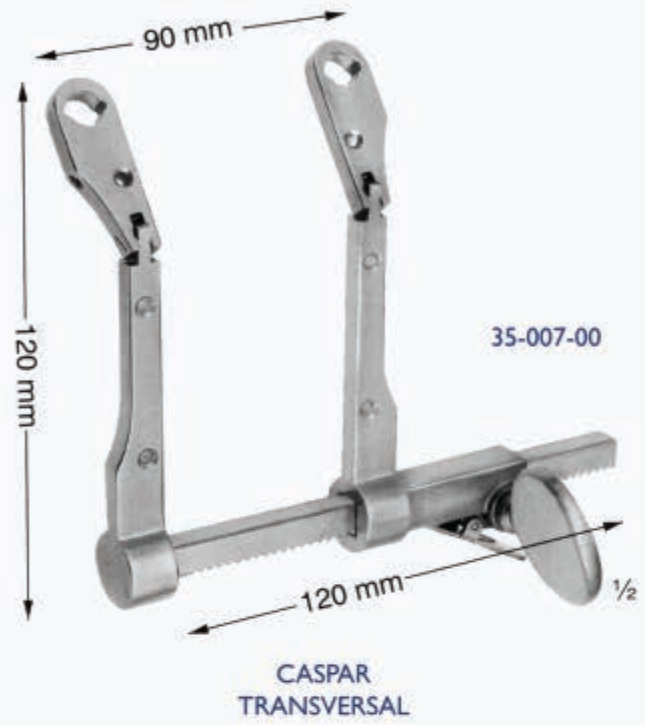

45 mm - 35-077-45
50 mm - 35-077-50
55 mm - 35-077-55
60 mm - 35-077-60
65 mm - 35-077-65



45 mm - 35-078-45
50 mm - 35-078-50
55 mm - 35-078-55
60 mm - 35-078-60
65 mm - 35-078-65



45 mm - 35-075-45
50 mm - 35-075-50
55 mm - 35-075-55
60 mm - 35-075-60
65 mm - 35-075-65



45 mm - 35-076-45
50 mm - 35-076-50
55 mm - 35-076-55
60 mm - 35-076-60
65 mm - 35-076-65



SCOVILLE
RETO

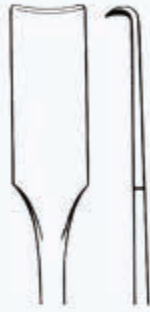

08 mm - 35-019-08
13 mm - 35-019-13



SCOVILLE
ANGULADO

08 mm - 35-017-08
13 mm - 35-017-13



BABY-INGE

16 CM
00-000-00

AGUDO
14 CM - 14-570-14
18 CM - 14-570-18
21 CM - 14-570-21

ROMBO
14 CM - 14-571-14
18 CM - 14-571-18
21 CM - 14-571-21

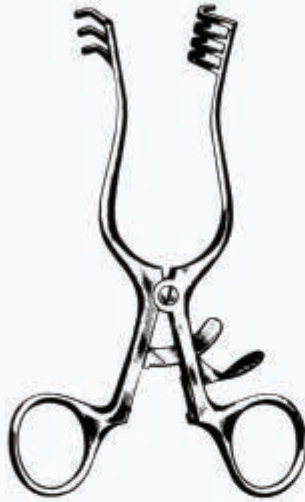

WEITLANER



TAYLOR

075 X 30 mm - 20-306-75
100 X 30 mm - 20-306-10



ADSON

3.0 mm - 16-030-30
3.5 mm - 16-030-35
4.0 mm - 16-030-40



FRAZIER

1.0 mm - 16-061-10
1.5 mm - 16-061-15
2.0 mm - 16-061-20
2.5 mm - 16-061-25
3.0 mm - 16-061-30
3.5 mm - 16-061-35
4.0 mm - 16-061-40
4.5 mm - 16-061-45
5.0 mm - 16-061-50



**FRAZIER C/PONTA PROTEGIDA
E CONTROLE DE FLUXO**

1.0 mm - 16-067-10
1.5 mm - 16-067-15
2.0 mm - 16-067-20
2.5 mm - 16-067-25
3.0 mm - 16-067-30
3.5 mm - 16-067-35
4.0 mm - 16-067-40
4.5 mm - 16-067-45
5.0 mm - 16-067-50

Nº 3 - 35-029-03
Nº 4 - 35-029-04



CABO DE BISTURI
EM BAIONETA



SERRA DE GIGLI

30 CM - 35-300-30
40 CM - 35-300-40
50 CM - 35-300-50

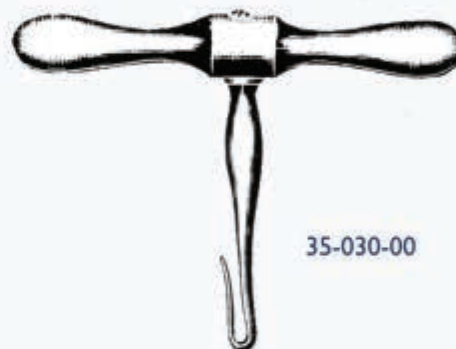

35-030-00

CABO P/SERRA DE GIGLI



35-048-01

MARTELL
SIMPLES



35-048-02

MARTELL
DUPLO



CLOWARD



10 mm - 35-036-10
12 mm - 35-036-12
14 mm - 35-036-14
16 mm - 35-036-16
18 mm - 35-036-18
20 mm - 35-036-20
22 mm - 35-036-22
24 mm - 35-036-24



LAMBOTTE
RETO



23 CM
06 mm - 20-331-06
10 mm - 20-331-10
15 mm - 20-331-15
20 mm - 20-331-20
25 mm - 20-331-25
30 mm - 20-331-30



LAMBOTTE
CURVO



23 CM
06 mm - 20-330-06
10 mm - 20-330-10
15 mm - 20-330-15
20 mm - 20-330-20
25 mm - 20-330-25
30 mm - 20-330-30



ZAUFAL-JANSEN

18 CM
5 X 15 mm - 20-473-18

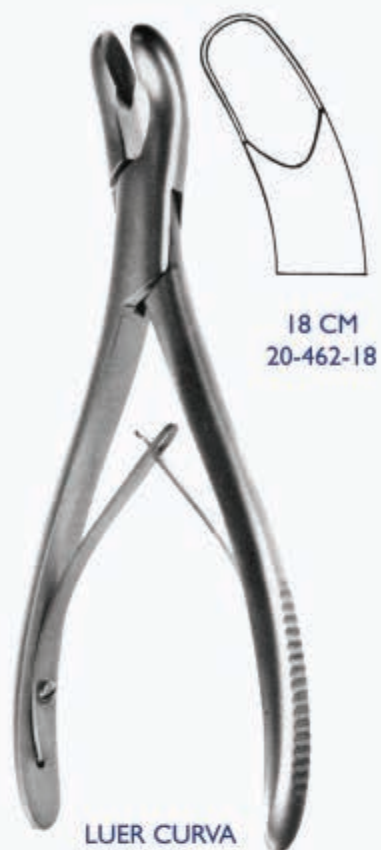



23 CM - 20-469-23
26 CM - 20-469-26

STILLE LUER
RETA

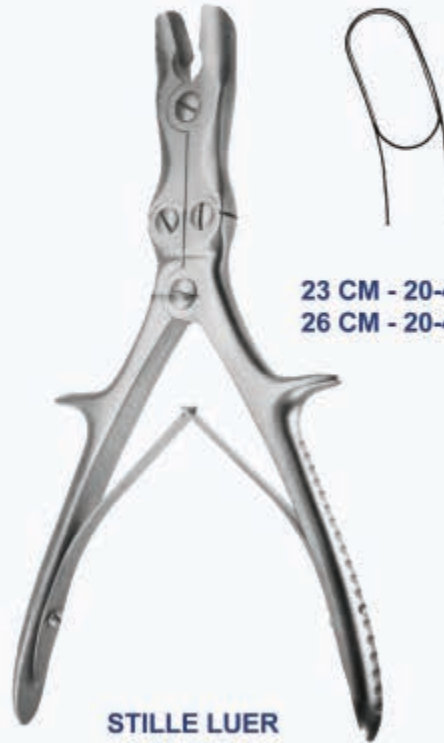

23 CM - 20-468-23
26 CM - 20-468-26

STILLE LUER
CURVA



5 mm - 20-426-05

DUCK BILL



5 mm 20-156-05
8 mm 20-156-08

LEKSELL

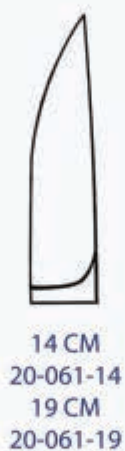

14 CM
20-061-14
19 CM
20-061-19

CIZALHA LISTON
RETA



14 CM
20-060-14
19 CM
20-060-19

CIZALHA LISTON
CURVA



27 CM
35-039-27

LISTON KEY



18 CM
20-073-18

RUSKIN RETA



18 CM
20-072-18

RUSKIN CURVA



STILLE LISTON
RETA



23 CM - 20-079-23
27 CM - 20-079-27



STILLE LISTON
CURVA



23 CM - 20-078-23
27 CM - 20-078-27



HALLE
MALEÁVEL

21 CM



Nº 1
35-049-01



Nº 2
35-049-01



Nº 3
35-049-03



SIMON
23 CM



SPRATT
18 CM





COBB



15 CM
35-052-15



FRAZIER



45°
35-054-45
15 CM

HOEN

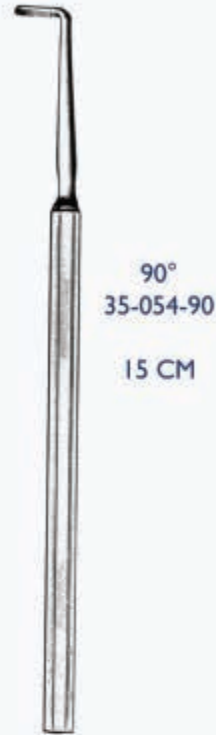

90°
35-054-90
15 CM

HOEN



21 CM
35-055-21

MILLIGAN



23 CM
2 X 3 mm
35-056-23

OLIVECRONA



25 CM
4 X 5 mm
35-056-25

OLIVECRONA



22 CM
3 mm - 35-058-03
6 mm - 35-058-06

SACHS

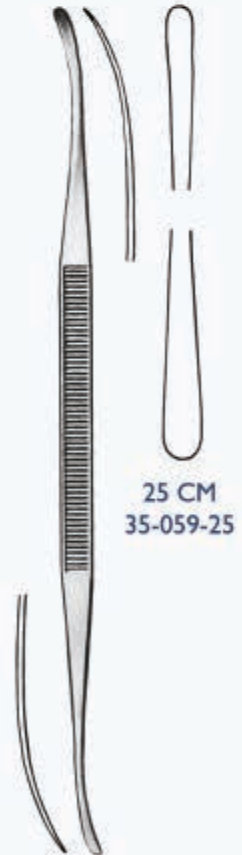

25 CM
35-059-25

TOENNIS



N° 1
35-057-01

PENFIELD

N° 2
35-057-02

PENFIELD

N° 3
35-057-03

PENFIELD

N° 4
35-057-04

PENFIELD

N° 5
35-057-05

PENFIELD



15 CM
20-481-16

RUGINA
FARABEUZ RETA

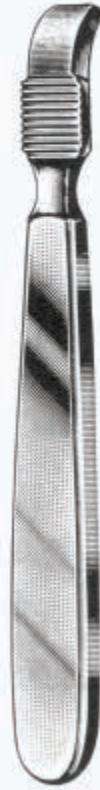

15 CM
20-480-16

RUGINA
FARABEUZ CURVA



6 mm - 51-540-06
8 mm - 51-540-08

JOSEPH 16 CM



4 mm - 35-064-04
5 mm - 35-064-05
6 mm - 35-064-06
7 mm - 35-064-07

CUSHING



19 cm
15 mm - 35-066-15
20 mm - 35-066-20

HOEN

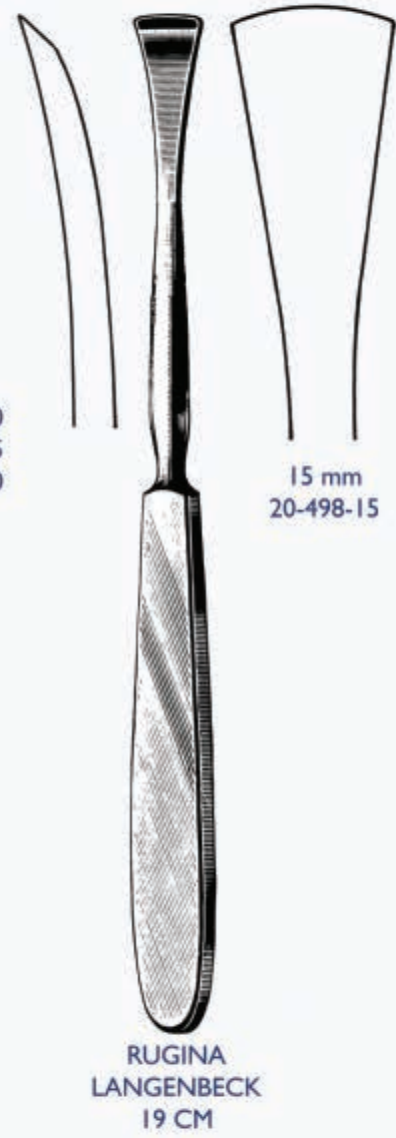
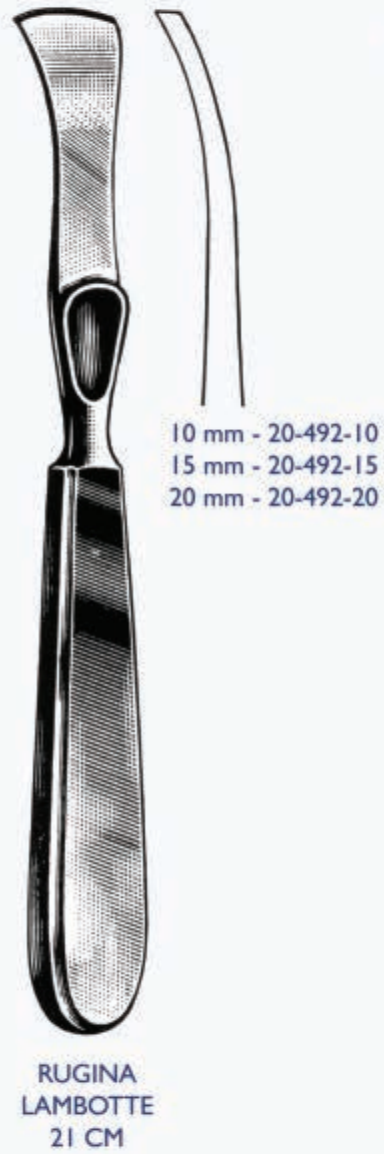

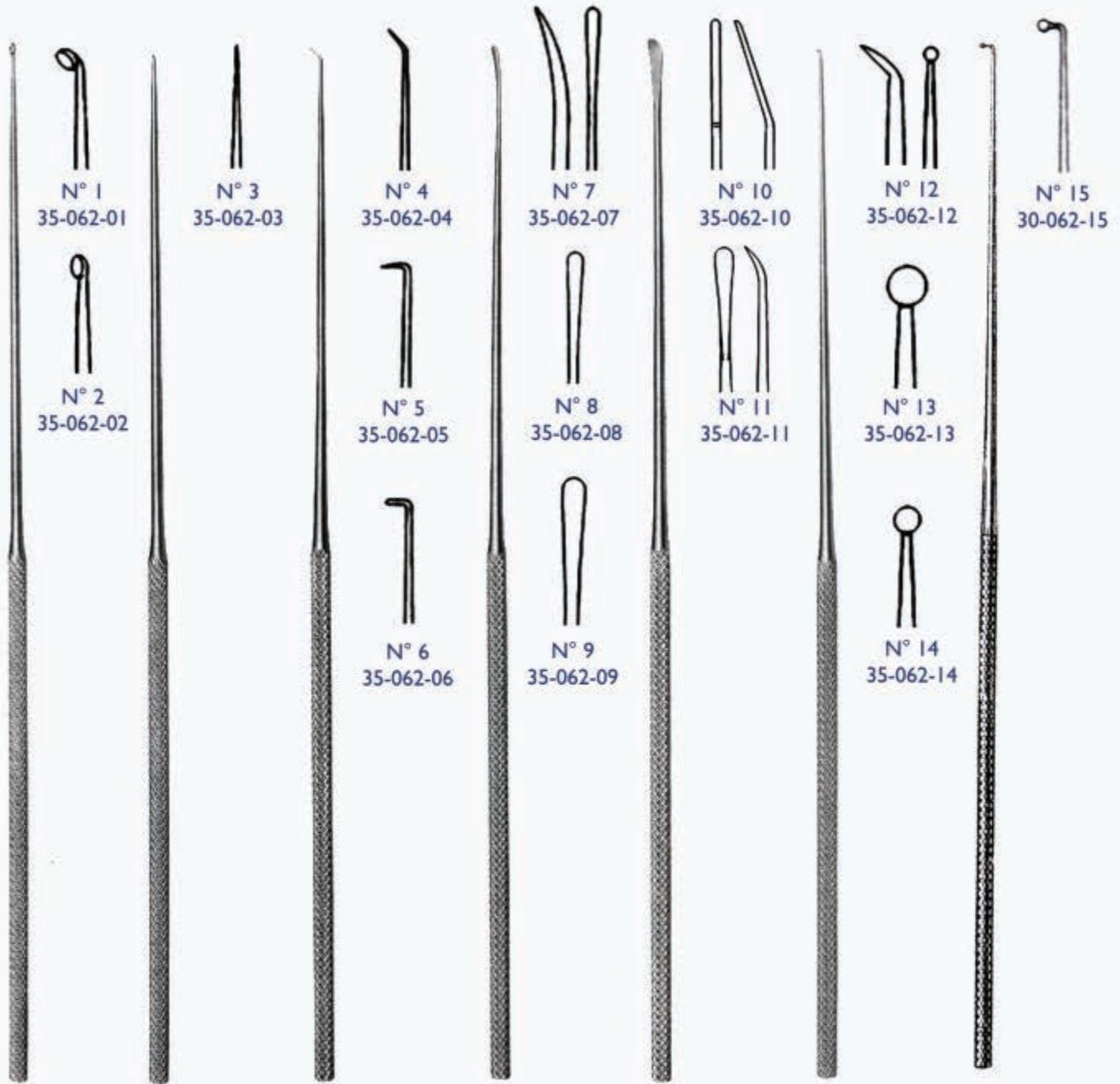

MICRO DISSECTORES RHOTON

JOGO COMPLETO 35-062-00





ESPÁTULA
DAVIS

20 CM
 06 mm - 35-068-06
 08 mm - 35-068-08
 10 mm - 35-068-10
 12 mm - 35-068-12
 14 mm - 35-068-14
 16 mm - 35-068-16
 18 mm - 35-068-18
 20 mm - 35-068-20
 22 mm - 35-068-22
 24 mm - 35-068-24

JOGO COM 10
 35-068-00



ESPÉCULO
HARDY
 90 mm - 35-070-90



ESPÉCULO
NASAL
KILLIAN

Nº 1 - 51-278-01
 Nº 2 - 51-278-02
 Nº 3 - 51-278-03
 Nº 4 - 51-278-04



GANCHO
MALIS

19 CM
 2 mm - 35-084-02
 3 mm - 35-084-03

19 CM
 2 mm - 35-088-02
 3 mm - 35-088-03



14 CM
35-110-14

PERFURADOR
MANUAL



35-112-15

PINÇA ADSON
P/ DURA



15 CM - 35-108-15
18 CM - 35-108-18

PINÇA APLICADORA
MC KENZIE

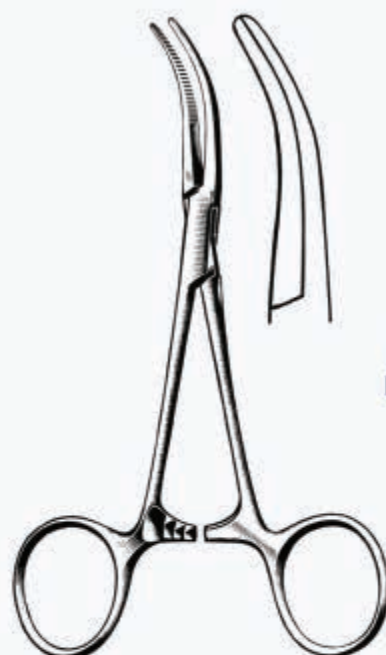



14 CM
13-320-14

PINÇA
DANDY

	TAMANHO	CÓDIGO
	3 mm	35-116-03
	5 mm	35-116-05



CLOWARD HARPER

	TAMANHO	CÓDIGO
	3 mm	35-115-03
	4 mm	35-115-04
	3 mm	35-114-03
	4 mm	35-114-04
	3 mm	35-113-03
	4 mm	35-113-04



CLOWARD



FERRIS SMITH
KERRISON

90° PARA CIMA	
TAMANHO	CÓDIGO
1 mm	35-124-01
2 mm	35-124-02
3 mm	35-124-03
5 mm	35-124-05

40° PARA CIMA	
TAMANHO	CÓDIGO
1 mm	35-120-01
2 mm	35-120-02
3 mm	35-122-03
5 mm	35-120-05

90° PARA BAIXO	
TAMANHO	CÓDIGO
1 mm	35-125-01
2 mm	35-125-02
3 mm	35-125-03
5 mm	35-125-05



LOVE GRUENWALD

Ponta para Baixo.	
TAMANHO	CÓDIGO
2mm	35-136-02
3mm	35-136-03
4mm	35-136-04
Ponta para Cima	
TAMANHO	CÓDIGO
2mm	35-137-02
3mm	35-137-03
4mm	35-137-04
Ponta Reta	
TAMANHO	CÓDIGO
1mm	35-138-01
2mm	35-138-02
3mm	35-138-03
4mm	35-138-04



PINÇA P/ TUMOR
HUNT



PINÇA
JANSEN

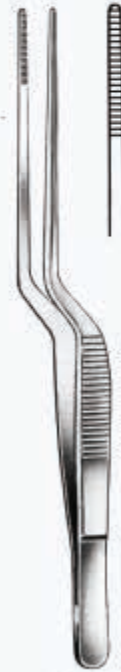

PINÇA
LUCAE



MARTEL



YASARGIL



YASARGIL



21 CM
75-294-21

YASARGIL



14 CM
35-354-14

TESOURA
TAYLOR

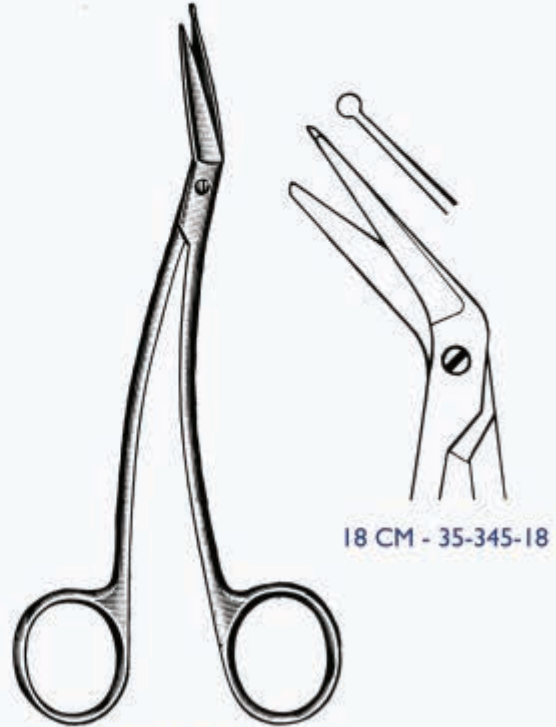

18 CM - 35-345-18

TESOURA
FRAZIER



13 CM - 51-600-13



TESOURA
OLIVECRONA



PONTA REG.
SOFTLINE
18 CM - 75-650-18
20 CM - 75-650-20
22 CM - 75-650-22

PONTA MICRO
18 CM - 75-653-18

METZ
18 CM - 75-654-18
20 CM - 75-654-20
22 CM - 75-654-22

YASARGIL

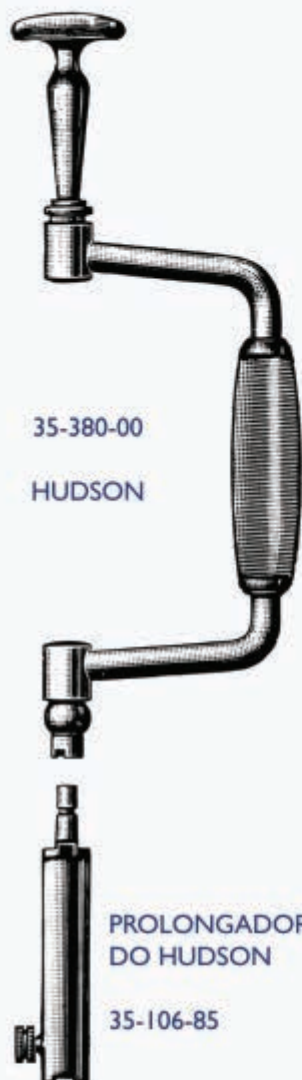

CUSHING
09 mm - 35-089-09
13 mm - 35-089-13



HUDSON
09 mm - 35-092-09



HUDSON
14 mm - 35-092-14



HUDSON

14 mm - 35-093-14
16 mm - 35-093-16
18 mm - 35-093-18
20 mm - 35-093-20
22 mm - 35-093-22



D'ERRICO

25 mm - 35-090-25
35 mm - 35-090-35
50 mm - 35-090-50



SMITH

35-094-00



TWIST DRILL

2,0 mm - 35-095-20
2,5 mm - 35-095-25
3,0 mm - 35-095-30

40
—



FOX



N° 1
40-048-01



N° 2
40-048-02



N° 3
40-048-03



GILLIES



DELICADO
14-672-01



FORTE
14-672-02



PUNCH

2,0 mm - 40-060-20
2,5 mm - 40-060-25
3,0 mm - 40-060-30
3,5 mm - 40-060-35
4,0 mm - 40-060-40
4,5 mm - 40-060-45
5,0 mm - 40-060-50
5,5 mm - 40-060-55
6,0 mm - 40-060-60

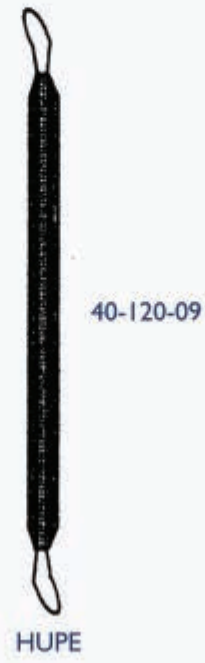
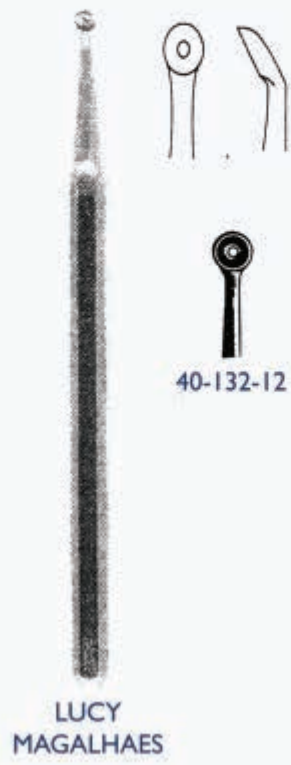

45
—



N° 1 - 45-120-01
N° 2 - 45-120-02
N° 3 - 45-120-03

PARA VIRGEM
45-120-00

COLLIN



130 mm
30 mm - 45-370-30
35 mm - 45-370-35

BREISK



AUVARD

085 X 40 mm	1,0 Kg	45-360-85
130 X 40 mm	1,2 Kg	45-360-13
150 X 33 mm	1,2 Kg	45-360-15



DOYEN

045 X 060 mm	14-745-60
045 X 090 mm	14-745-90
045 X 120 mm	14-745-12
060 X 120 mm	14-760-12
060 X 060 mm	14-760-60
060 X 090 mm	14-745-90



VELA DE HEGAR

JOGO C/25 PEÇAS
45-420-99

N° 01 - 45-420-01
N° 02 - 45-420-02
N° 03 - 45-420-03
N° 04 - 45-420-04
N° 05 - 45-420-05
N° 06 - 45-420-06
N° 07 - 45-420-07
N° 08 - 45-420-08
N° 09 - 45-420-09
N° 10 - 45-420-10

N° 11 - 45-420-11
N° 12 - 45-420-12
N° 13 - 45-420-13
N° 14 - 45-420-14
N° 15 - 45-420-15
N° 16 - 45-420-16
N° 17 - 45-420-17
N° 18 - 45-420-18
N° 19 - 45-420-19
N° 20 - 45-420-20

N° 21 - 45-420-21
N° 22 - 45-420-22
N° 23 - 45-420-23
N° 24 - 45-420-24
N° 25 - 45-420-25

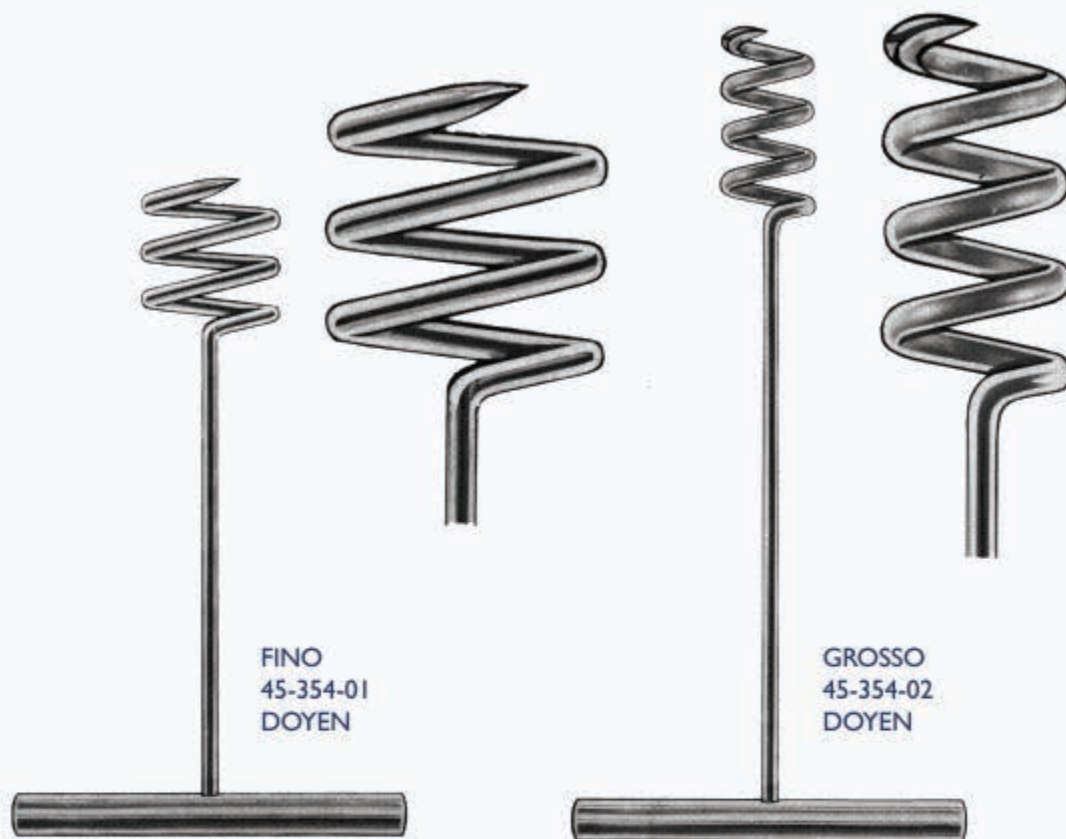

FINO
45-354-01
DOYEN

GROSSO
45-354-02
DOYEN

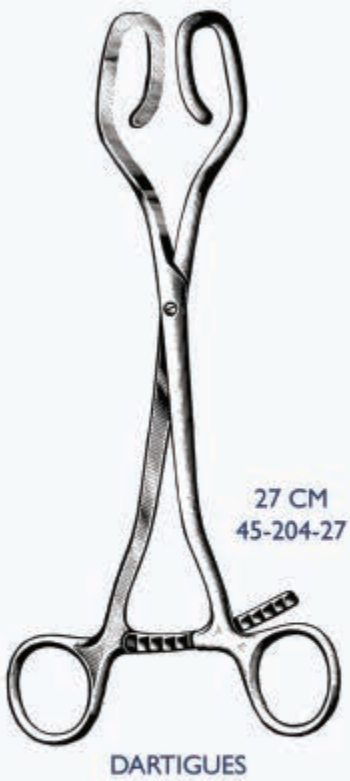





24 CM
45-300-24



THOMAS
GAYLOR



26 CM
45-320-26

WERTHEIM

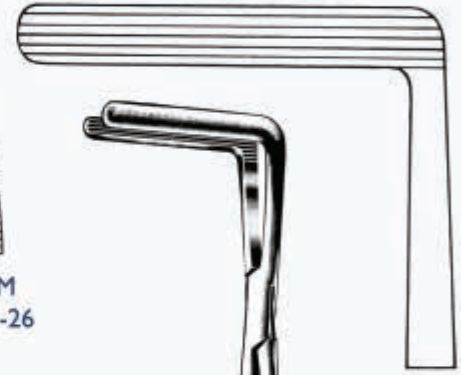

22 CM
45-324-22



WERTHEIM-CULLEN



20 CM - 17-018-20W
25 CM - 17-018-25W
30 CM - 17-018-30W

PORTA AGULHA
HEANEY CURVO
C/WÍDEA



20 CM
11-010-20

TESOURA
BALIÚ

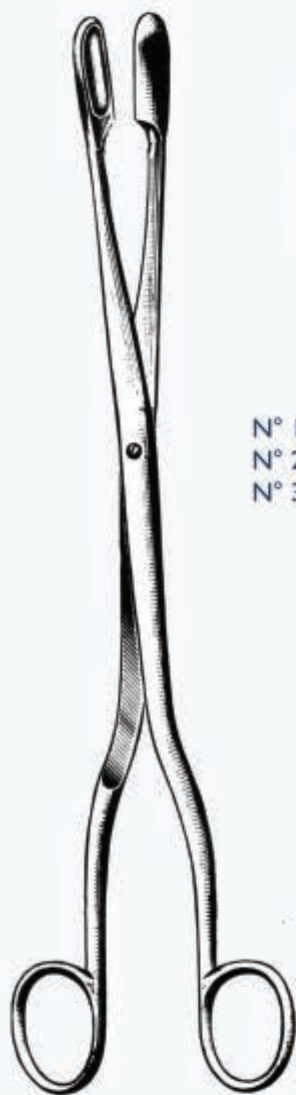

WINTER RETA
28 CM

N° 1 - 45-331-01
N° 2 - 45-331-02
N° 3 - 45-331-03



WINTER CURVA
28 CM

N° 1 - 45-330-01
N° 2 - 45-330-02
N° 3 - 45-330-03

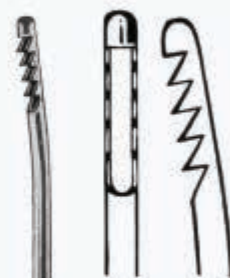

23 CM
4 mm - 45-048-23

CURETA DE
NOVAK



RÉCAMIER 30 CM

N°	1	2	3	4	5	6
CORTANTE	45-060-01	45-060-02	45-060-03	45-060-04	45-060-05	45-060-06
ROMBO	45-062-01	45-062-02	45-062-03	45-062-04	45-062-05	45-062-06



SCHOROEDER 30 CM

N° 1 45-072-01	N° 2 45-072-02
N° 3 45-072-03	N° 4 45-072-04
N° 5 45-072-05	N° 6 45-072-06

48
—



18 CM - 48-061-18
25 CM - 48-061-25

DOYEN INTESTINAL
RETA



ATRAUMA
18 CM - 48-121-18
21 CM - 48-121-21
23 CM - 48-121-23



18 CM - 48-060-18
25 CM - 48-060-25

DOYEN INTESTINAL
CURVA



ATRAUMA
18 CM - 48-120-18
21 CM - 48-120-21
23 CM - 48-120-23



20 CM - 48-300-20
29 CM - 48-300-29
35 CM - 48-300-35

CLAMP PAYR



22 CM - 48-181-22
25 CM - 48-181-25

KOECHER INTESTINAL RETA
ATRAUMA



22 CM - 48-180-22
25 CM - 48-180-25

KOECHER INTESTINAL CURVA
ATRAUMA



22 CM - 48-241-22
25 CM - 48-241-25

KOECHER INTESTINAL
RETA

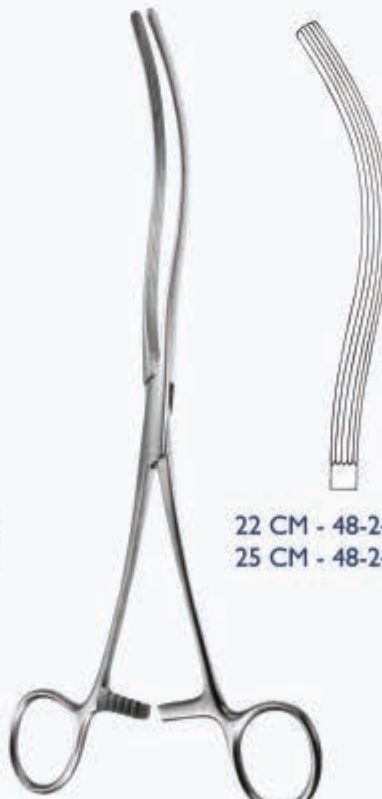

22 CM - 48-240-22
25 CM - 48-240-25

KOECHER INTESTINAL
CURVA





22 CM
48-100-00

CZEMY

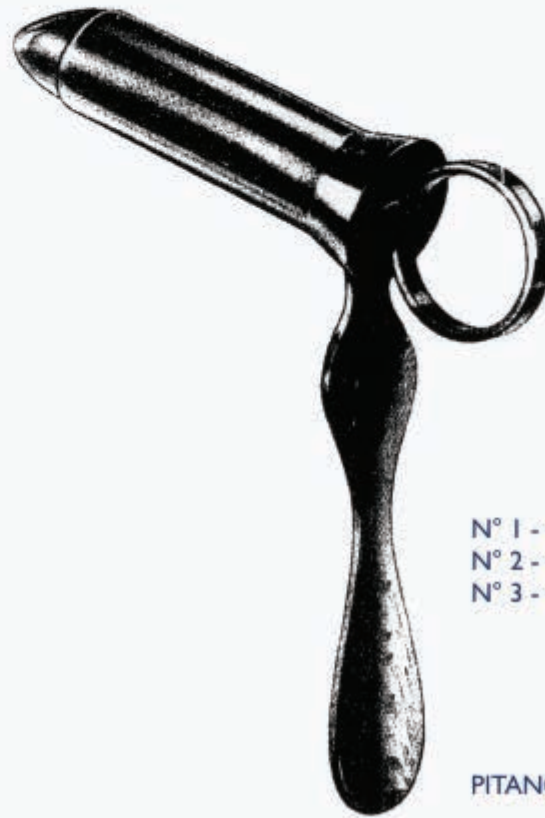

N° 1 - 48-006-16
N° 2 - 48-006-19
N° 3 - 48-006-23

PITANGA

49
—

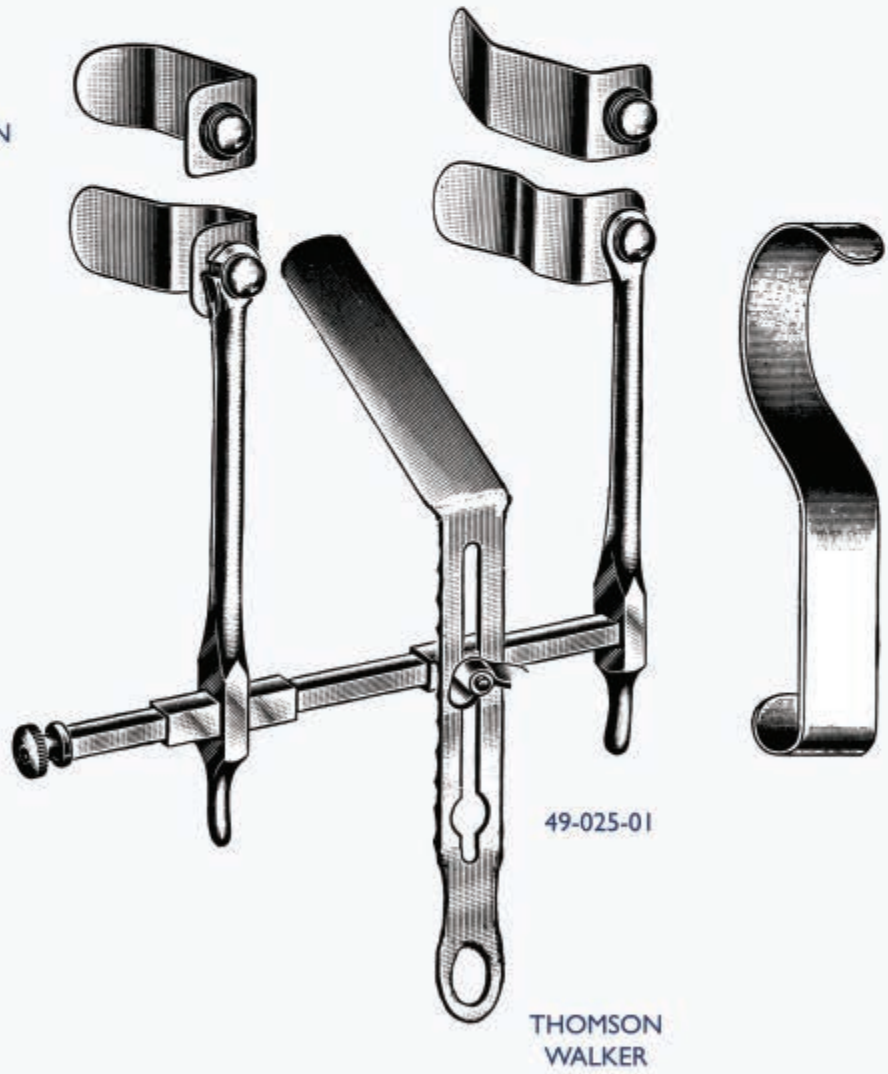

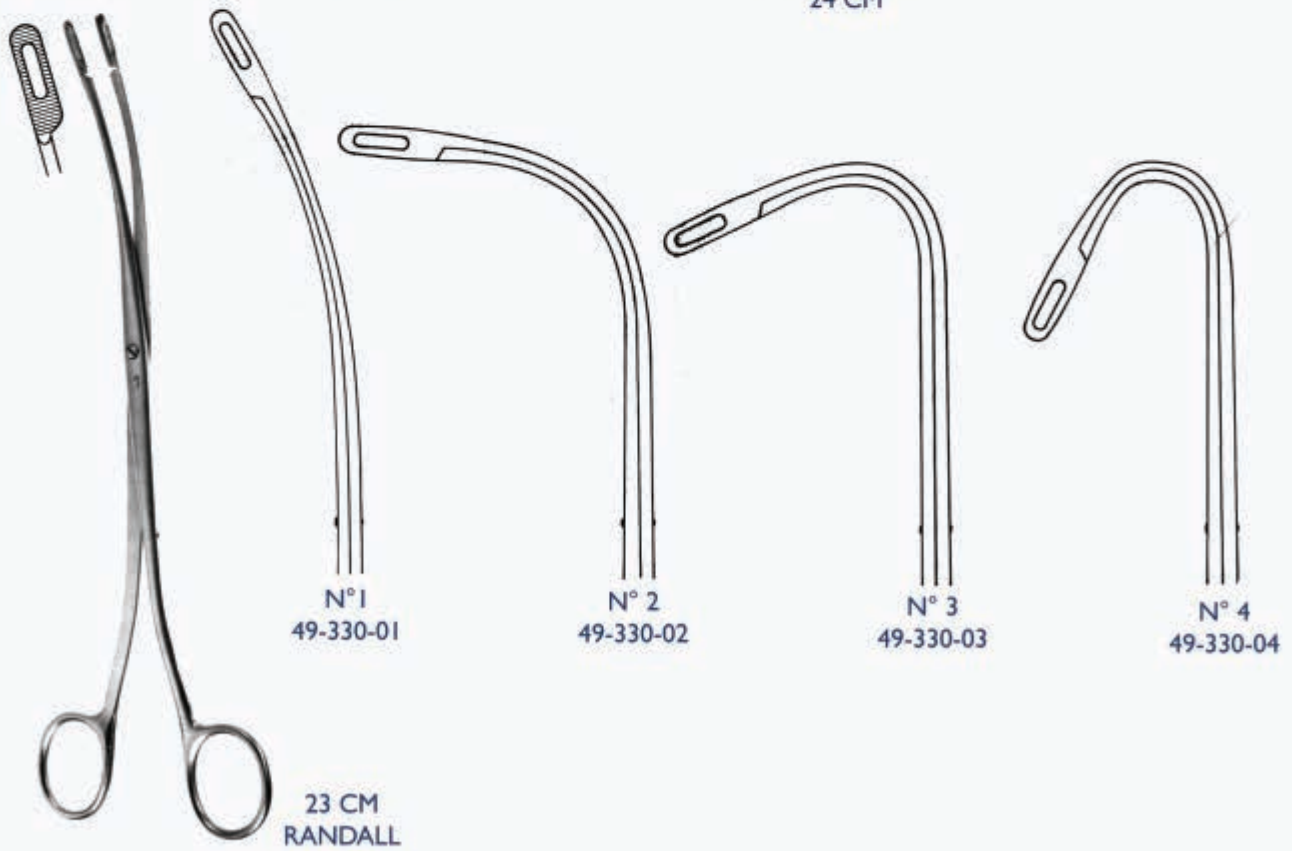
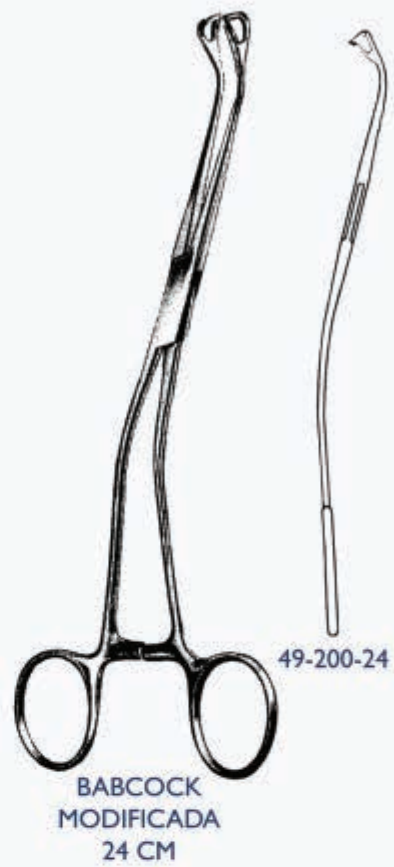



20 CM - 49-238-20
28 CM - 49-238-28

MATHIEU



20 CM - 49-240-20
28 CM - 49-240-28

MATHIEU P/ CORPO
ESTRANHO



DILATADOR
BAKES
30 CM

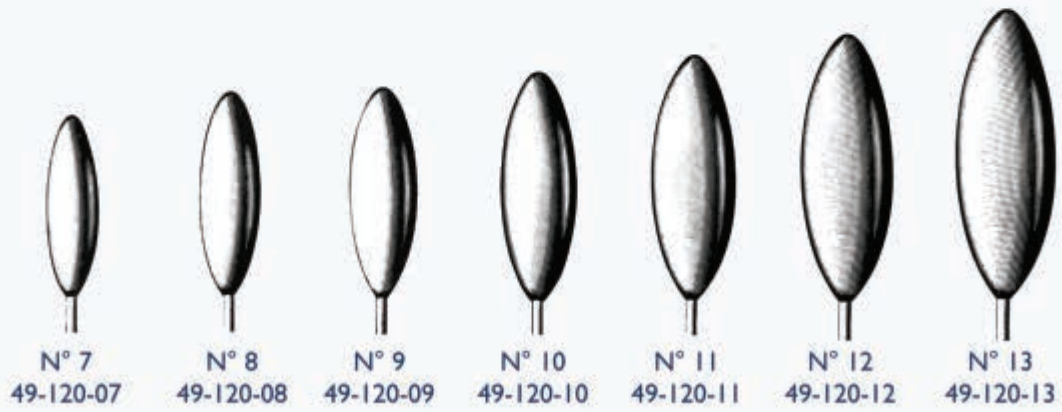

JOGO COMPLETO COM 13 PEÇAS
49-120-00



BENIQUÊ DE GUYON 28 CM

N°	CÓDIGO	N°	CÓDIGO
20	49-048-20	42	49-048-42
22	49-048-22	44	49-048-44
24	49-048-24	46	49-048-46
26	49-048-26	48	49-048-48
28	49-048-28	50	49-048-50
30	49-048-30	52	49-048-52
32	49-048-32	54	49-048-54
34	49-048-34	56	49-048-56
36	49-048-36	58	49-048-58
38	49-048-38	60	49-048-60
40	49-048-40		

JOGO COMPLETO COM 21 PEÇAS
49-048-00

50

50-240-00



HARTMANN
ADULTO
JOGO C/3

50-246-01

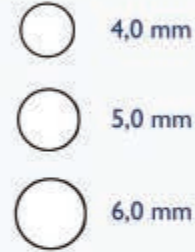

KILLIAN
JOGO C/4



20 mm
50-090-20

CASTROVIEJO



ASPIRAÇÃO DE
OUVIDO



50-330-00

INTERMEDIARIO

10 CM
0,5 mm - 50-024-05
0,6 mm - 50-024-06
0,7 mm - 50-024-07
0,8 mm - 50-024-08
0,9 mm - 50-024-09
1,0 mm - 50-024-10
1,2 mm - 50-024-12
1,5 mm - 50-024-15
1,8 mm - 50-024-18
2,0 mm - 50-024-20
2,5 mm - 50-024-25
3,0 mm - 50-024-30



N° 1 - 50-480-01
N° 2 - 50-480-02
N° 3 - 50-480-03

ITARD 14 CM



18 CM
50-042-18

LUCAE
BAIONETA



50-048-16

POLITZER
ANGULADA



16 CM
50-270-16

JACOBSON
P/ CORPO
ESTRANHO



16 CM
50-294-16

MOLDENHAUER
P/ CORPO
ESTRANHO



14 CM
50-318-14

GANCHO
P/CERUMEM



12 CM - 50-348-12
14 CM - 50-348-14

HARTMANN



50-354-09

PINÇA
HARTMANN NOYES 9 CM



50-380-08

MICRO PINÇA
HOUSE-DIETER 8 CM



DIREITA
50-404-08



ESQUERDA
50-406-08



RETA
50-407-08



MICRO PINÇA
JACARÉ 8 CM



8 CM - 50-420-08

MICRO PINÇA
SACA BOCADO



RETA
50-513-08



DIREITA
50-510-08



ESQUERDA
50-512-08



MICRO TESOURA
BELLUCI 8 CM

51



18 CM
51-012-19

AUFRICHT



12 CM
14-144-12

CONVERSE

Nº 1
51-270-00 (INFANTIL)
51-270-01



Nº 2
51-270-02

Nº 3
51-270-03



HARTMANN
15 CM



06mm
14-654-06

08mm
14-654-08

10mm
14-654-10

GANCHO DUPLO
C/BOLA



06mm
14-660-06

08mm
14-660-08

10mm
14-660-10

GANCHO DUPLO
PONTA FINA



06mm
14-666-06

08mm
14-666-08

10mm
14-666-10

GANCHO DUPLO
PONTA ROMBA



RETA
51-490-23

DIREITA
51-490-23D

ESQUERDA
51-490-23E

WALSHAM
23CM



N° 1 - 51-278-01
 N° 2 - 51-278-02
 N° 3 - 51-278-03
 N° 4 - 51-278-04

KILLIAN AUTO
 ESTÁTICO
 14 CM

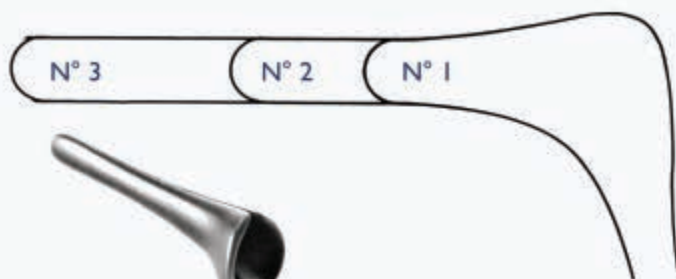

N° 1 - 51-276-01
 N° 2 - 51-276-02
 N° 3 - 51-276-03

KILLIAN
 14 CM



23 CM
 51-360-23 - CURVA
 51-361-23 - RETA

PINÇA
 ASCH



N° 1
 51-390-01



N° 2
 51-390-02



N° 3
 51-390-03

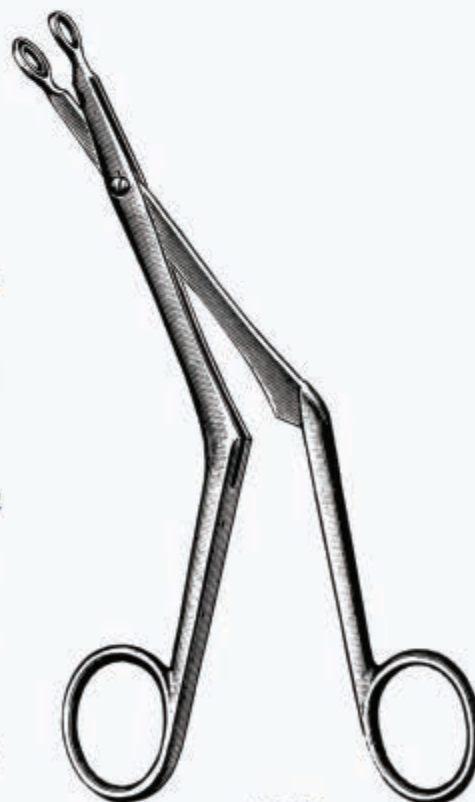

19 CM
 BRUENINGS

51-414-10



COTTLE
P/COLUMELA



16 CM - 51-426-16
19 CM - 51-426-19

HARTMANN



14 CM - 51-450-14

HARTMANN NOYES
P/ CORPO ESTRANHO



19 CM - 12-468-19
21 CM - 12-468-21

PINÇA
JANSEN



14 CM - 12-510-14
16 CM - 12-510-16

LUCAE



51-438-00

19 CM
MIDLETON
JANSEN FENESTRADA

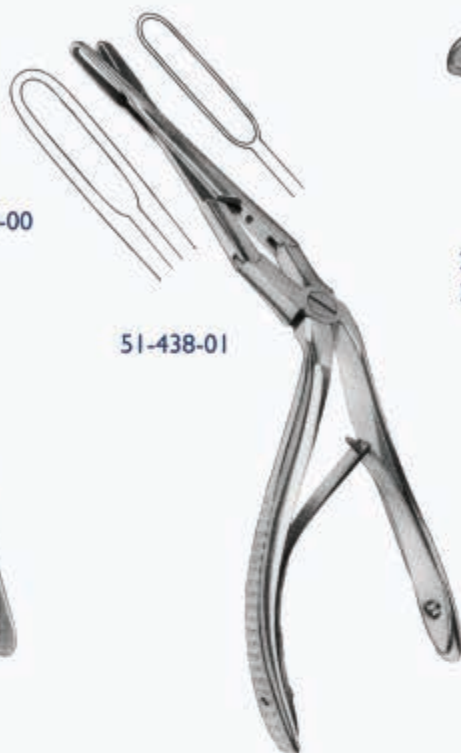

51-438-01

19 CM
MIDLETON JANSEN
GOIVA



2 mm - 50-340-02
3 mm - 50-340-03

CITELLI



13 CM
51-498-13



WEIL-BLAKESLEY



13 CM
51-462-13

STRUYCKEN

51-468-13 ADULTO-ANGULADA
51-469-13 ADULTO-RETA
51-473-13 FENESTRADA RETA
51-470-11 INFANTIL-ANGULADA
51-471-11 INFANTIL-RETA



12 CM
TAKAHASHI



51-066-20

DESCOLADOR
ASPIRADOR
DESMONTÁVEL



51-060-20

DESCOLADOR
ASPIRADOR
DR.ALENCAR



20 CM
51-072-20

DESCOLADOR
COTTLE



20 CM
51-078-20

DESCOLADOR
FREER



20 CM
51-096-20

DESCOLADOR
MASING



51-103-19

DESCOLADOR
NEVES PINTO
RETO



51-102-19

DESCOLADOR
NEVES PINTO
CURVO



51-048-15

BISTURI
FREER P/
SEPTO



JOSEPH



6 mm - 51-540-06
8 mm - 51-540-08



06 mm - 51-180-06
08 mm - 51-180-08
10 mm - 51-180-10
12 mm - 51-180-12
14 mm - 51-180-14

ESCOPRO C/
1 GUIA



06 mm - 51-192-06
08 mm - 51-192-08
10 mm - 51-192-10
12 mm - 51-192-12
14 mm - 51-192-14

ESCOPRO C/
2 GUIAS



P/DIREITA
6 mm - 51-181-06
8 mm - 51-181-08
10 mm - 51-181-10
12 mm - 51-181-12
14 mm - 51-181-14

ESCOPRO CURVO
C/1 GUIA



P/ ESQUERDA
06 mm - 51-183-06
08 mm - 51-183-08
10 mm - 51-183-10
12 mm - 51-183-12
14 mm - 51-183-14

ESCOPRO CURVO
C/1 GUIA

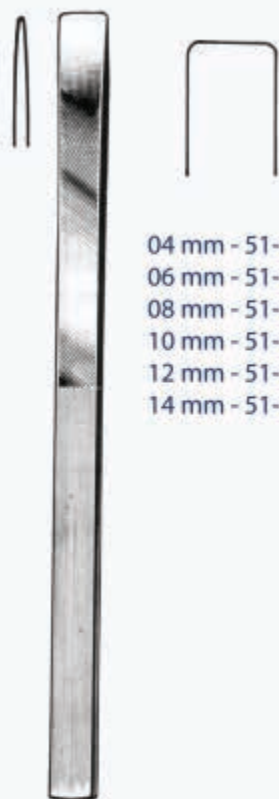

04 mm - 51-222-04
06 mm - 51-222-06
08 mm - 51-222-08
10 mm - 51-222-10
12 mm - 51-222-12
14 mm - 51-222-14

ESCOPRO
S/GUIA



04 mm - 51-182-04
06 mm - 51-182-06
08 mm - 51-182-08
10 mm - 51-182-10
12 mm - 51-182-12
14 mm - 51-182-14

ESCOPRO CURVO
S/GUIA



2 mm - 51-198-02
3 mm - 51-198-03
4 mm - 51-198-04

ESCOPRO P/
FRATURA
EXTERNA

51-246-00



ESMAGADOR DE
CARTILAGEM
DE COTTLE



FACA BECKMANN
22 CM



Nº 1
52-172-01



Nº 2
52-172-02



Nº 3
52-172-03



Nº 4
52-172-04



Nº 5
52-172-05



Nº 6
52-172-06



19 CM
Nº 3 - 51-289-03

FACA BALLENGER
RETA



FACA
BALLENGER
BAIONETA



19 CM
Nº 1 - 51-288-01
Nº 2 - 51-288-02
Nº 3 - 51-288-03



RASPA AUFRICHT
P/ BAIXO



CURVA
51-510-20

RETA
51-513-20



CURVA
51-512-20

RETA
51-515-20



RASPA AUFRICHT
P/ CIMA

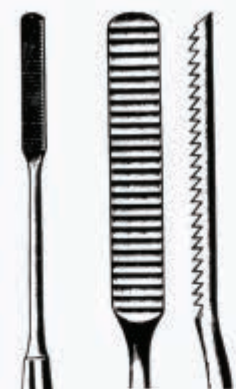

51-518-20

RASPA MALTZ
AND. RETA
P/CIMA



RASPA
JOSEPH
DIREITA



51-564-19

RASPA DE
JOSEPH
ESQUERDA



51-566-19



RASPA
PEET C/WÍDIA 18 CM

WÍDIA
CURVA
51-522-18W
RETA
51-523-18W



RASPA
SPERLI 18 CM

CURVA
51-528-18

RETA
51-529-18



320G
20-372-32

MARTELO MEAD C/CABEÇAS
INTERCAMBIÁVEIS



250G
20-378-25

MARTELO
PARTSCH

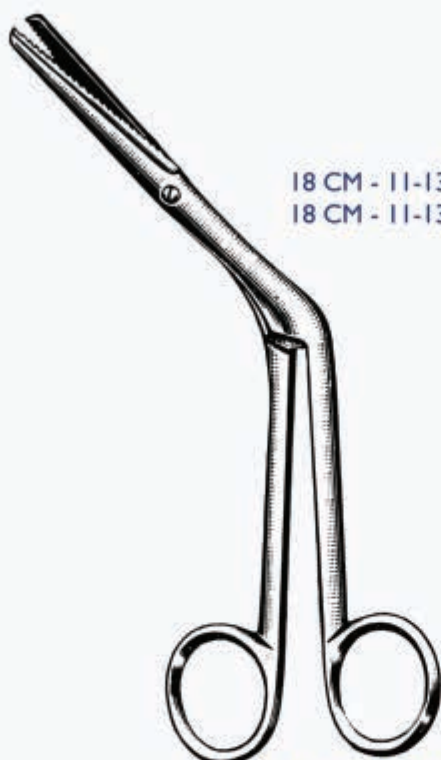

18 CM - 11-132-18S
18 CM - 11-132-18SSL

TESOURA HEYMANN
ANGULADA C/ SERRILHA

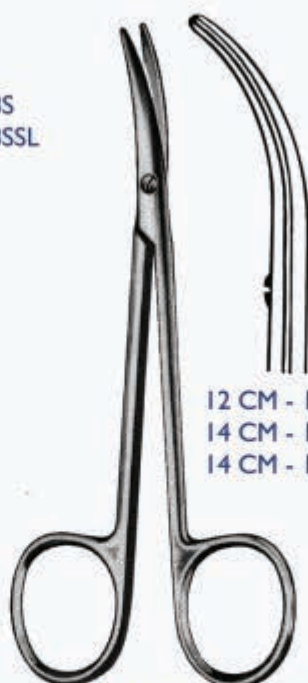

12 CM - 11-096-12
14 CM - 11-096-14
14 CM - 11-096-14SSL

TESOURA
FOMON



18 CM - 11-102-18S

TESOURA
FOMON ACOTOVELADA
SERRILHADA



SERRILHADA
18 CM - 11-241-18S

SPECIAL LINE
18 CM - 11-241-18SSL

WÍDEA
18 CM - 11-241-18W

TESOURA
MC INDOE



SERRILHADA
18 CM - 11-084-18S

SPECIAL LINE
18 CM - 11-084-18SSL

WÍDIA
18 CM - 11-084-18W

SERRILHADA
18 CM - 11-084-18WS

TESOURA
COTTLE ANGULADA

52

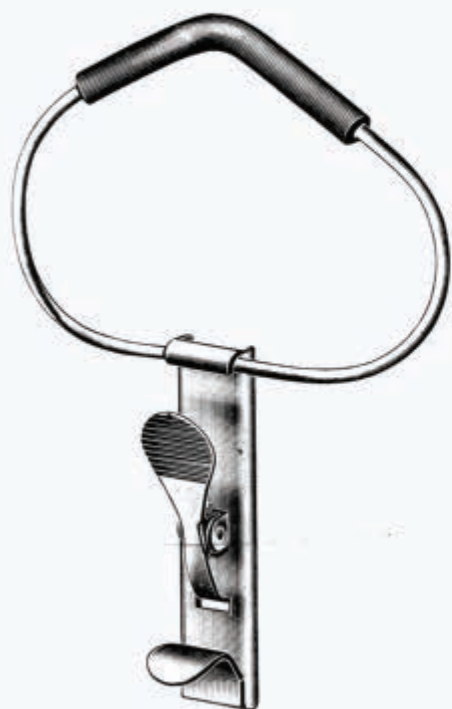

MC IVOR



52-042-00



- 25 X 70 mm
- 25 X 80 mm
- 25 X 85 mm
- 25 X 90 mm



52-012-00

ANDREW

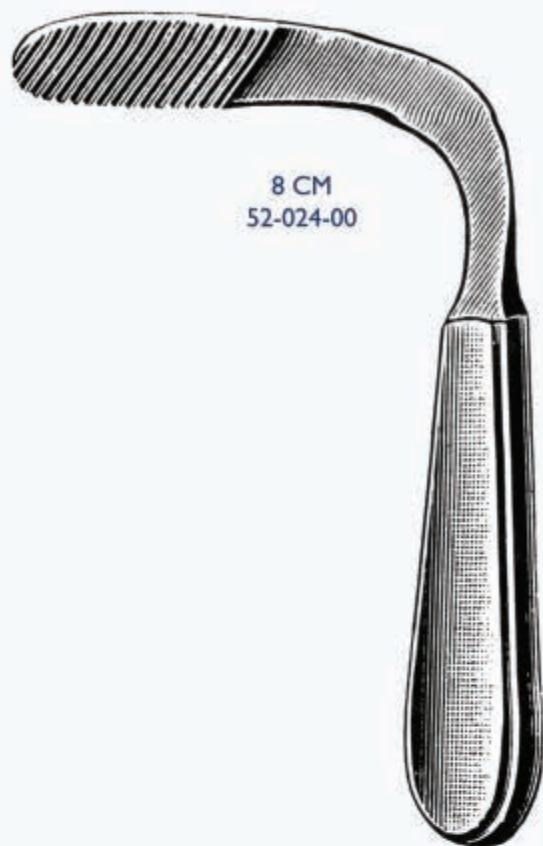

8 CM
52-024-00

ABAIXA LINGUA
TOBOLD



19 CM
52-018-19

ABAIXA LINGUA
BRÜNINGS

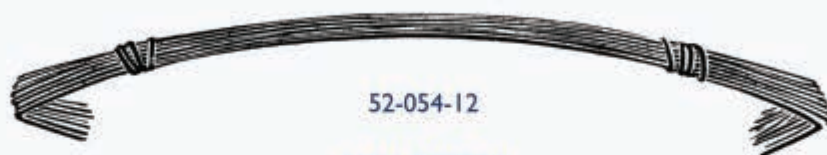

52-054-12

ALÇA P/SERRA
NÓ

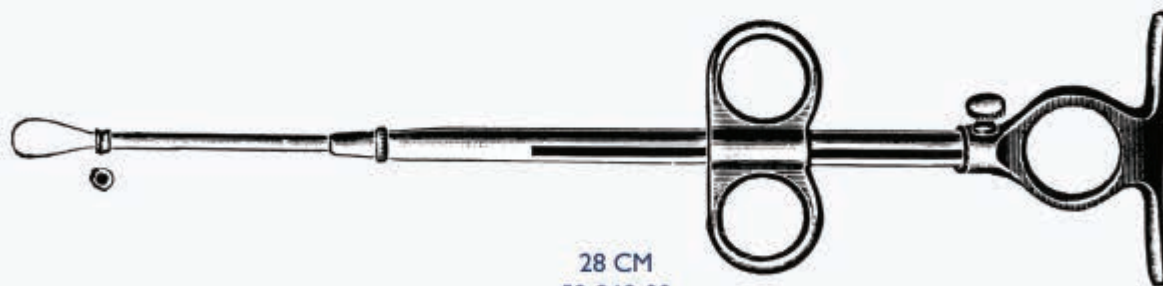

28 CM
52-268-00

SERRA NÓ EVES

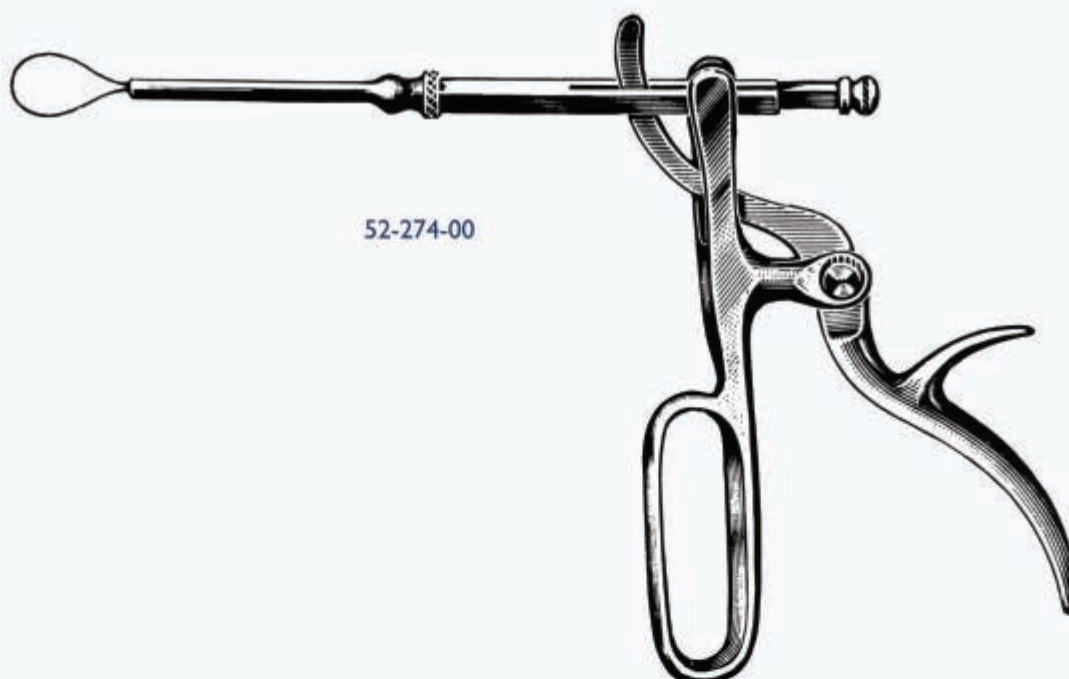

52-274-00

SERRA NÓ SAGE
TIPO REVÓLVER



FACA BECKMANN
22 CM



N° 1
52-172-01



N° 2
52-172-02



N° 3
52-172-03



N° 4
52-172-04



N° 5
52-172-05



N° 6
52-172-06



PINÇA SCOUBE
ALLIS



MIXTER

23 CM
13-480-23



SCHNIDT CURVA

19 CM
52-389-19



CABO P/ ESPELHO
52-060-09



23 CM
52-102-23

DESCOLADOR
HURD



DESCOLADOR
FOWLER
SERRILHADO

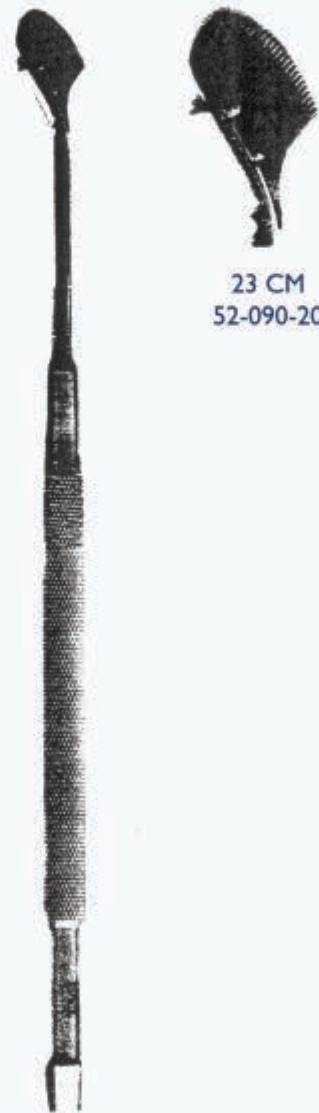

DESCOLADOR
ASPIRADOR FOWLER
SERRILHADO

55
—



11 CM - 55-036-11
13 CM - 55-036-13
15 CM - 55-036-15

JENNINGS



10 CM - 55-040-10
14 CM - 55-040-14

MOLT

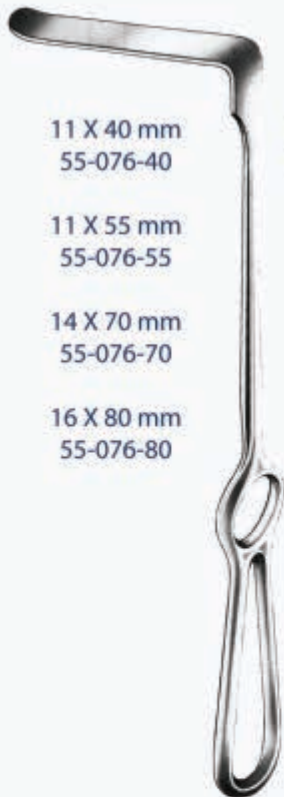

11 X 40 mm
55-076-40

11 X 55 mm
55-076-55

14 X 70 mm
55-076-70

16 X 80 mm
55-076-80

OBWEGESER
P/ CIMA



06 X 25 mm - 55-076-25
08 X 35 mm - 55-076-35
11 X 40 mm - 55-076-40
11 X 55 mm - 55-076-55
14 X 70 mm - 55-076-70
16 X 80 mm - 55-076-80

OBWEGESER
P/ BAIXO



10 X 42 mm
55-077-10

11 X 70 mm
55-077-10

OBWEGESER
P/CIMA EM "V"

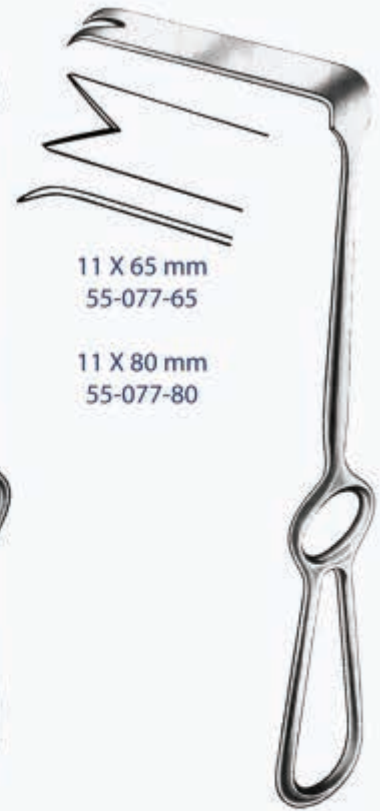

11 X 65 mm
55-077-65

11 X 80 mm
55-077-80

OBWEGESER
P/BAIXO EM "V"



13 CM
55-101-13

AGULHA
OBWEGESER



WÍDIA
17 CM - 20-024-17W

ALICATE
CORTE LATERAL
DUPLA FORÇA



18 CM
17-120-18W

P/ FIO DE AÇO CWÍDIA



55-392-02

55-390-02

ROWE
P/ ESQUERDA

ROWE
P/ DIREITA

60



ASTON

RETA
17 CM - 11-005-17
19 CM - 11-005-19

WÍDIA
17 CM - 11-005-17W
19 CM - 11-005-19W

CURVA SERRILHADA
17 CM - 11-006-17S
19 CM - 11-006-19S

WÍDIA
17 CM - 11-006-17W
19 CM - 11-006-19W



BOETTCHER

18 CM - 11-024-18

SERRILHADA
18 CM - 11-024-18S

SPECIAL LINE
18 CM - 11-024-18SSL

WÍDEA
18 CM - 11-024-18W



BOYD CURVA EM S

14 CM - 11-036-14
18 CM - 11-036-18
20 CM - 11-036-20

WÍDIA
14 CM - 11-036-14W
18 CM - 11-036-18W
20 CM - 11-036-20W



CONVERSE

12 CM - 11-072-12

SERRILHADA
12 CM - 11-072-12S

SPECIAL LINE
12 CM - 11-072-12SSL

WÍDIA
12 CM - 11-072-12W



COTTLE

SERRILHADA
18 CM - 11-084-18S

SPECIAL LINE
18 CM - 11-084-18SSL

WÍDIA
18 CM - 11-084-18W



12 CM - 11-096-12
14 CM - 11-096-14

SPECIAL LINE
12 CM - 11-096-12SSL
14 CM - 11-096-14SSL

FOMON



18 CM - 11-102-18S

FOMON ACOTOVELADA
SERRILHADA

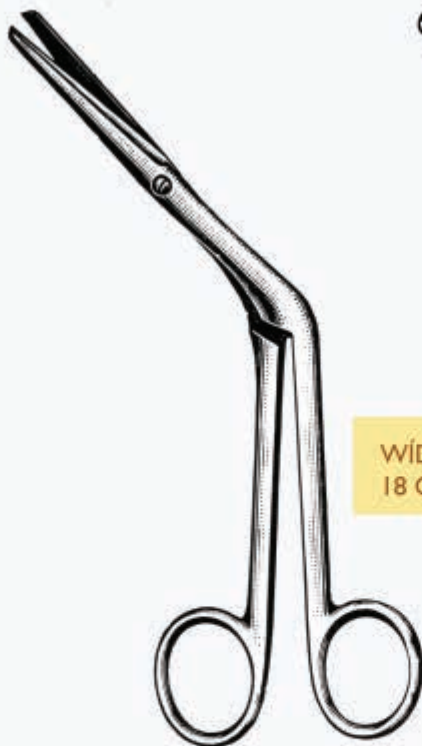

HEYMANN
ANGULADA



HEYMANN
ANGULADA C/ SERRILHA

18 CM - 11-132-18S

SPECIAL LINE
18 CM - 11-132-18SSL

WIDEA
18 CM - 11-132-18SW

WIDEA
18 CM - 11-132-18W

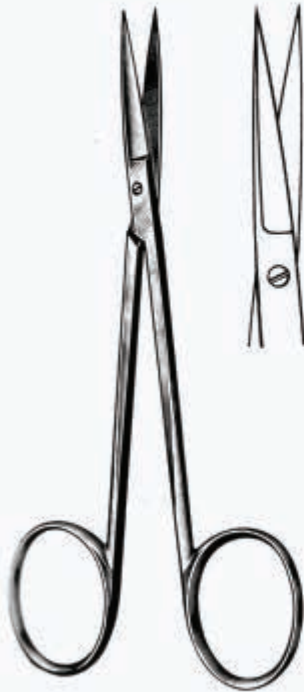

IRIS RETA

12 CM - 11-151-12

SERRILHADA
12 CM - 11-151-12S

SPECIAL LINE
12 CM - 11-151-12SSL

PTA ROMBA
12 CM - 11-153-12

WÍDEA
12 CM - 11-151-12W

PTA ROMBA
12 CM - 11-153-12W



IRIS CURVA

12 CM - 11-150-12

SERRILHADA
12 CM - 11-150-12S

SPECIAL LINE
12 CM - 11-150-12SSL

PTA ROMBA
12 CM - 11-152-12

WÍDEA
12 CM - 11-150-12W

PTA ROMBA
12 CM - 11-152-12W



JOSEPH

14 CM - 11-163-14
18 CM - 11-163-18

SERRILHADA
14 CM - 11-163-14S
18 CM - 11-163-18S

SPECIAL LINE
14 CM - 11-163-14SSL
14 CM - 11-161-14SSL

PTA ROMBA
14 CM - 11-165-14
18 CM - 11-165-18

WÍDEA
14 CM - 11-163-14W
18 CM - 11-163-18W

PTA ROMBA
14 CM - 11-165-14W
18 CM - 11-165-18W



JOSEPH CURVA

14 CM - 11-162-14
18 CM - 11-162-18

SERRILHADA
14 CM - 11-162-14S
18 CM - 11-162-18S

SPECIAL LINE
14 CM - 11-162-14SSL
14 CM - 11-161-14SSL

PTA ROMBA
14 CM - 11-164-14
18 CM - 11-164-18

WÍDEA
14 CM - 11-162-14W
18 CM - 11-162-18W

PTA ROMBA
14 CM - 11-164-14W
18 CM - 11-164-18W



KILNER CURVA

12 CM - 11-180-12
14 CM - 11-180-14

SPECIAL LINE
12 CM - 11-180-12SSL
14 CM - 11-180-14SSL

WÍDEA
12 CM - 11-180-12W
14 CM - 11-180-14W



MC INDOE

SERRILHADA
18 CM - 11-241-18S

SPECIAL LINE
18 CM - 11-241-18SSL

WÍDEA
18 CM - 11-241-18W

SERRILHADA
18 CM - 11-241-18SS

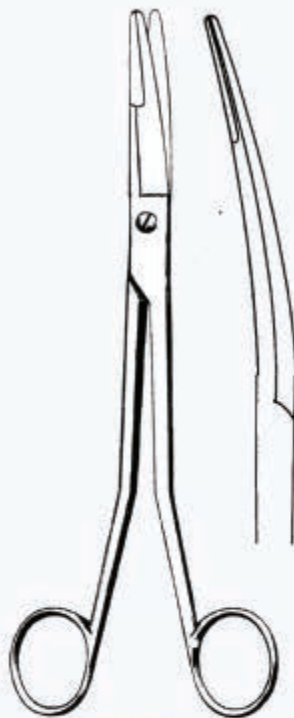

REES

18 CM - 11-444-18
20 CM - 11-444-20

SPECIAL LINE
18 CM - 11-444-18SSL
20 CM - 11-444-20SSL

WÍDEA
18 CM - 11-444-18W
20 CM - 11-444-20W

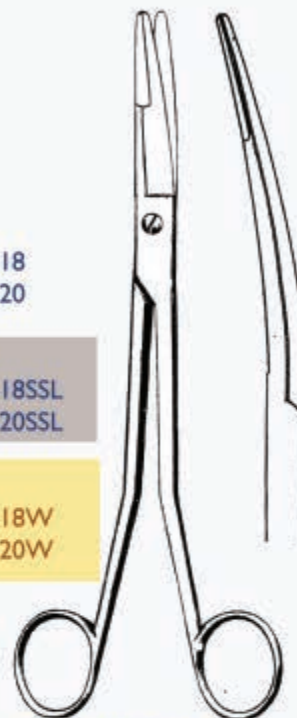

REES SERRILHADA

18 CM - 11-444-18S
20 CM - 11-444-20S

SPECIAL LINE
18 CM - 11-444-18SSL
20 CM - 11-444-20SSL

WÍDEA
18 CM - 11-444-18W
20 CM - 11-444-20W



REYNOLD CURVA

14 CM - 11-468-14

SERRILHADA
14 CM - 11-468-14S

SPECIAL LINE
14 CM - 11-468-14SSL

WÍDEA
14 CM - 11-468-14W



REYNOLD RETA

14 CM - 11-469-14

SERRILHADA
14 CM - 11-469-14S

SPECIAL LINE
14 CM - 11-469-14SSL

WÍDEA
14 CM - 11-469-14W

09 CM - 11-515-09
12 CM - 11-515-12

WÍDEA
12 CM - 11-515-12W



SPENCER RETA



STEVENS PONTA
ROMBA

RETA
11 CM - 11-543-11
18 CM - 11-543-18

WÍDEA
11 CM - 11-543-11W
18 CM - 11-543-18W

SPECIAL LINE
11 CM - 11-543-11SSL
18 CM - 11-543-18SSL

CURVA
11 CM - 11-542-11
18 CM - 11-542-18

SPECIAL LINE
11 CM - 11-542-11SSL
18 CM - 11-542-18SSL

WÍDEA
11 CM - 11-542-11W
18 CM - 11-542-18W



STEVENS PONTA
FINA

RETA
11 CM - 11-541-11
18 CM - 11-541-18

WÍDEA
11 CM - 11-541-11W
18 CM - 11-541-18W

SPECIAL LINE
11 CM - 11-541-11SSL
18 CM - 11-541-18SSL

CURVA
11 CM - 11-540-11
18 CM - 11-540-18

SPECIAL LINE
11 CM - 11-540-11SSL
18 CM - 11-540-18SSL

WÍDEA
11 CM - 11-540-11W
18 CM - 11-540-18W



21CM - 70-464-21R
23CM - 70-464-23R

TESOURA
METZENBAUM
REVESTIDA



12 CM - 12-180-12
15 CM - 12-180-15

MICRO
12 CM - 12-181-12
15 CM - 12-181-15

WÍDEA
12 CM - 12-180-12W
15 CM - 12-180-15W

12 CM - 12-181-12W
15 CM - 12-181-15W

ADSON



12 CM - 12-060-12
15 CM - 12-060-15

ADSON
BROWN



12 CM
12-210-12

ADSON
TIPO RELOJOEIRO RETA



12 CM - 12-120-12
15 CM - 12-120-15

MICRO
12 CM - 12-121-12
15 CM - 12-121-15

WÍDEA
12 CM - 12-120-12W
15 CM - 12-120-15W

12 CM - 12-121-12W
15 CM - 12-121-15W

ADSON
C/DENTE



12 CM
12-211-12

ADSON
TIPO RELOJOEIRO 45°



13-466-00

PINÇA
CALAZZIO C/ CHAPA
FECHADA



14 CM
60-462-14

MARTEL
P/ COURO CABELUDO



15 CM
60-484-15

PITANGUY
MARCAÇÃO DE FACE



32 CM
60-484-32

PITANGUY
MARCAÇÃO DE ABDOMEN



21 CM
70-468-21R

JANSEN
BAIONETA MONOPOLAR



21 CM - 70-400-21R
23 CM - 70-400-23R

LONGUETE CURVA
REVESTIDA



14 CM - 70-420-14R
16 CM - 70-420-16R

KELLY
CURVA REVESTIDA



06 mm - 70-008-06R
08 mm - 70-008-08R
10 mm - 70-008-10R
12 mm - 70-008-12R
14 mm - 70-008-14R
16 mm - 70-008-16R
18 mm - 70-008-18R

AFASTADOR
DESMARRES REVESTIDO



CABO
P/ PINÇA MONOPOLAR
AUTOCLAVÁVEL

3 M - 642-100-20
5 M - 642-100-22



70-018-03R

CABO DE BISTURI
N°3 REVESTIDO



70-018-04R

CABO DE BISTURI
N°4 REVESTIDO



AEREOLÓTOMO INOX
JOGO C/2

60-120-03



60-324-10

COMPASSO 100 mm



60-324-20

COMPASSO 200 mm



Nº4
20 CM - 10-033-20
24 CM - 10-033-24



Nº4
16 CM - 10-032-16
20 CM - 10-032-20
24 CM - 10-032-24

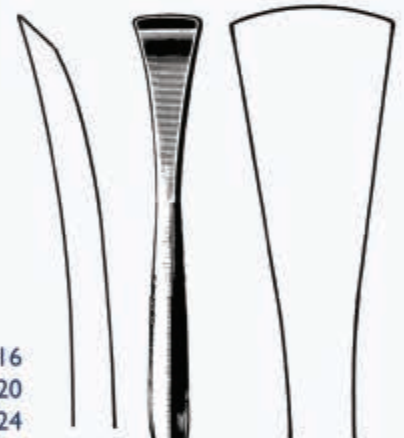

15 mm
20-498-15



020 mm
50-090-20

COMPASSO
CASTROVIEJO

CABO DE BISTURI
CURVO

CABO DE BISTURI

RUGINA
LANGENBECK



60-450-03
ORELHA DE ABANO
KIT COM 2 RASPAS E
1 DESCOLADOR

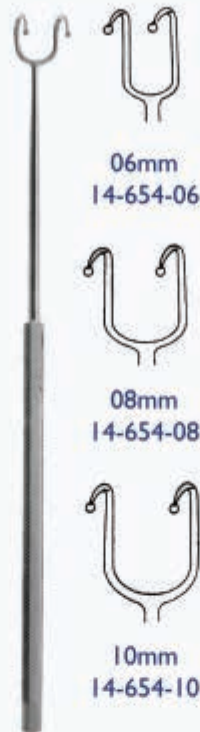

GANCHO DUPLO
C/BOLA



GANCHO DUPLO
PONTA FINA

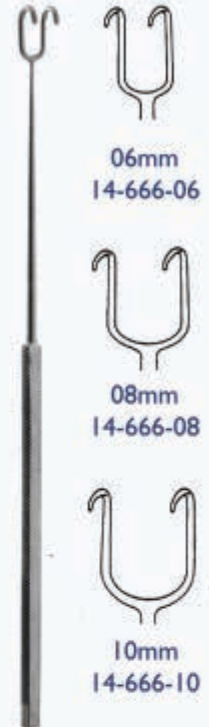

GANCHO DUPLO
PONTA ROMBA

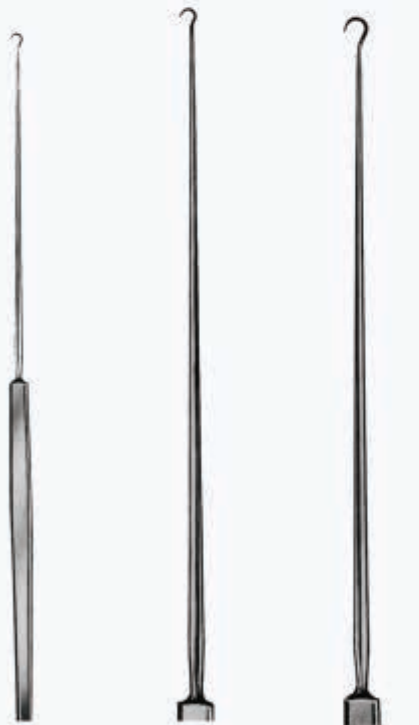

GILLIES

DELICADO
14-672-01

FORTE
14-672-02



JOSEPH
SIMPLES



GANCHO P/MAMA
C/ARGOLA



AUFRICHT



12 CM
14-144-12

CONVERSE



16 CM
14-688-16

GANCHO
RASTELO



14-120-06

BARRAQUER
BLEFAROSTATO

62



TESOURA PARA
MICROCIRURGIA
AÇO INOX

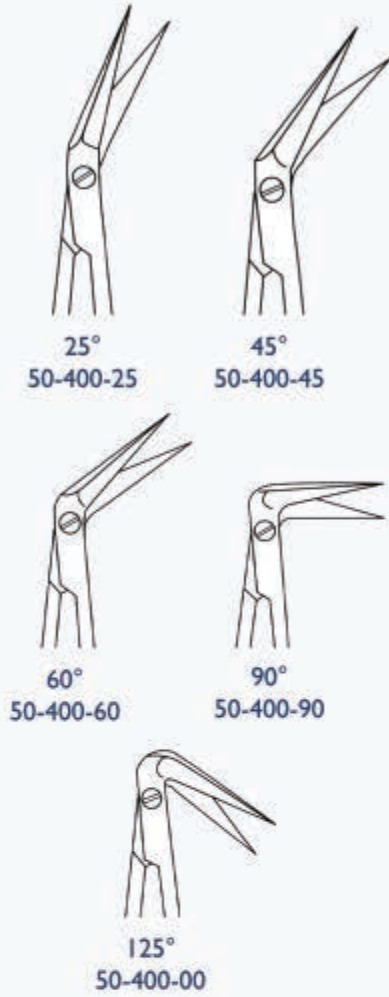

TESOURA PARA
MICROCIRURGIA
AÇO INOX





15 CM - 30-574-15
18 CM - 30-574-18
21 CM - 30-574-21
23 CM - 30-574-23

PINÇA PARA
MICROCIRURGIA
C/ANEL
AÇO INOX



15 CM - 30-574-15T
18 CM - 30-574-18T
21 CM - 30-574-21T
23 CM - 30-574-23T

PINÇA PARA
MICROCIRURGIA
C/ANEL
TITÂNIO





15 CM - 30-589-15
18 CM - 30-589-18
21 CM - 30-589-21

PINÇA PARA
MICROCIRURGIA
C/ATRAUMA
AÇO INOX



15 CM - 30-589-15T
18 CM - 30-589-18T
21 CM - 30-589-21T

PINÇA PARA
MICROCIRURGIA
C/ATRAUMA
TITÂNIO



15 CM - 30-568-15
18 CM - 30-568-18
21 CM - 30-568-21
23 CM - 30-568-23

PINÇA PARA
MICROCIRURGIA
C/DENTE RETA AÇO INOX



15 CM - 30-568-15T
18 CM - 30-568-18T
21 CM - 30-568-21T
23 CM - 30-568-23T

PINÇA PARA
MICROCIRURGIA C/DENTE RETA
TITÂNIO



15 CM - 30-569-15
18 CM - 30-569-18
21 CM - 30-569-21
23 CM - 30-569-23

PINÇA PARA
MICROCIRURGIA
C/DENTE CURVA AÇO INOX



15 CM - 30-569-15T
18 CM - 30-569-18T
21 CM - 30-569-21T
23 CM - 30-569-23T

PINÇA PARA
MICROCIRURGIA C/DENTE CURVA
TITÂNIO



15 CM - 30-564-15
18 CM - 30-564-18
21 CM - 30-564-21
23 CM - 30-564-23

PINÇA PARA
MICROCIRURGIA
S/DENTE RETA AÇO INOX



15 CM - 30-565-15
18 CM - 30-565-18
21 CM - 30-565-21
23 CM - 30-565-23

PINÇA PARA
MICROCIRURGIA
S/DENTE CURVA AÇO INOX



15 CM - 30-564-15T
18 CM - 30-564-18T
21 CM - 30-564-21T
23 CM - 30-564-23T

PINÇA PARA
MICROCIRURGIA S/DENTE RETA
TITÂNIO



15 CM - 30-565-15T
18 CM - 30-565-18T
21 CM - 30-565-21T
23 CM - 30-565-23T

PINÇA PARA
MICROCIRURGIA S/DENTE CURVA
TITÂNIO



PORTA AGULHA
PARA MICROCIRURGIA
AÇO INOX



15 CM - 17-002-15
18 CM - 17-002-18
21 CM - 17-002-21
23 CM - 17-002-23



15 CM - 17-003-15
18 CM - 17-003-18
21 CM - 17-003-21
23 CM - 17-003-23



PORTA AGULHA
PARA MICROCIRURGIA
TITÂNIO



15 CM - 17-002-15T
18 CM - 17-002-18T
21 CM - 17-002-21T
23 CM - 17-002-23T



15 CM - 17-003-15T
18 CM - 17-003-18T
21 CM - 17-003-21T
23 CM - 17-003-23T

A

ADSON	
Afastador auto estático	14-15, 35-02
Cânula de aspiração	16-01, 35-13
Pinça dissecação	12-01, 60-06
Pinça dissecação angulada	12-02
Pinça dissecação c/dente	12-01, 60-06
Pinça dissecação c/serrilha	12-02
Pinça para dura	35-29
ADSON BECKMANN	
Afastador auto estático	14-16, 35-01
ADSON BECKMANN EATON	
Afastador auto estático	14-16, 35-01
ADSON BROWN	
Pinças Dissecação	12-02, 60-06
AGULHA	
C/Ponta para heparina	30-23
P/Aspiração de ouvido	50-01
ALÇA P/ SERRA NÓ	52-03
ALICATE	
Corte Lateral	20-10
Corte Lateral Dupla Força	20-10, 30-06, 55-02
Extração de fio de aço	20-11
Paralelo de cortar e puxar fio inox	20-11
Pressão Inox	20-11
Ricardão	20-12
ALLIS	
Pinça intestinal	13-06
ALM	
Afastador	14-13
ANDREW	
Abaixa Língua	52-01
ANEL CRAWFORD	30-23
ANKENEY	
Afastador	30-01

APLICADORA DE BULLDOGS	30-08
AREOLÓTOMO INOX JOGO C/2	60-09
ASCH	
Pinça para septoplastia	51-02
ASTON	
Tesoura p/plástica	11-13, 60-61
AUFRIEHT	
Afastador nasal	51-01, 60-10
Raspa nasal	51-07
AUTO CENTRANTE	
Pinça óssea	20-09
AUVARD	
Valva pesante	45-02

B

BABCOCK	
Pinça intestinal	13-06
BABCOCK MODIFICADA	
Pinça urológica	49-02
BABY-INGE	
Afastador p/coluna	35-12
BACKHAUS	
Pinça p/campo	13-08
BAILEY	
Aproximador de costelas	20-03
BAKES	
Dilatador biliar	49-04
BALFOUR	
Afastador auto estático	14-05
Valva p/afastador	14-12
BALIÚ	
Tesoura	11-14, 45-06

BALLENGER Faca para adenóide	51-07	BOETTCHER Tesoura	11-14, 60-01
BARRAQUER Porta agulha Blefarostato Tesoura oftálmica	17-06, 17-05, 30-29 14-13, 60-11 11-13	BOYD Tesoura vascular	11-14, 30-30, 60-01
BAUMGARTNER Porta agulha	17-03	BOZEMANN Pinça p/assepcia	13-08, 45-04
BEACHAM Amniótomo	45-04	BREISK Espécuro vaginal	45-01
BECK Clamp cardiovascular	30-19	BRUENINGS Pinça cortante nasal	51-02
BECKMANN Faca para adenóide	51-07, 52-04	BRÜNINGS Abaixa língua	52-02
BELLUCI Micro tesoura	50-04	BRUNS Cureta	20-20
BENNET Elevador ósseo	20-14	C	
BENT-HOHMANN Afastador p/joelho	20-23	CABO DE BISTURI Cabo de Bisturi Em baioneta Revestido	10-01, 10-02, 60-09 35-14 60-08
BEYER Pinça goiva	20-04, 35-17	CABO MONOPOLAR AUTOCLAVÁVEL CABO P/ ESPELHO DE LARINGE CABO P/ SERRA DE GIGLI	60-08 52-05 35-15
BI OLIVAR Estilete	15-01	CAIFA MEDINA Fleboextrator	30-23
BIPOLAR BAIONETA Pinça dissecação	60-07	CALÁZIO Pinça chapa fechada	60-07
BLAIR-ROLLET Gancho delicado	14-02	CASPAR Afastador p/neuro	35-03
BLOUNT Elevafor ósseo	20-14	CASPAR CORPO VERTEBRAL Afastador p/neuro	35-04
BOEHLER Estribo	24-24		

CASPAR LONGITUDINAL CERVICAL Afastador p/neuro	35-11	COLLIN RETA Pinça p/assepcia	13-07
CASPAR TRANSVERSAL Afastador p/neuro	35-11	COMPASSO	60-09
CASTROVIEJO Compasso	50-01, 60-09	CONVERSE Gancho	14-02, 51-01, 60-11
Porta agulha	17-07, 17-08, 30-30	Tesoura nasal	11-14, 60-01
Tesoura	11-13	COOLEY Afastador atrial	30-04
CHAVE APLICADORA Para Caspar	35-04	Cânula de aspiração	16-01
CHERON Pinça p/assepcia	13-07, 45-04	COTTLE Descolador duplo nasal	51-05
CITELLI Pinça cortante nasal	51-04	Esmagador de cartilagem	51-06
CLOWARD Afastador articulado	35-02	Pinça para columela	51-03
Cinzel	35-15	Tesoura nasal	11-14, 60-01
Pinça p/laminectomia	35-30	CRAFFORD Pinça p/assepcia	13-03
CLOWARD HARPER Pinça p/laminectomia	35-30	CRILE Pinça hemostática	13-02
CLOWARD LOMBAR POSTERIOR Afastador p/neuro	35-03	CRILE WOOD Porta agulha	17-02
CLOWARD P/VIA ANTERIOR Afastador p/neuro	35-03	CRUTCHFIELD Trator cranial	35-36
COBB Rugina	20-15, 35-22	Trépano manual	35-14
COLLIN Espéculo vaginal	45-01	CUSHING Fresa p/trépano	35-37
Pinça porta instrumental	13-07	Rugina	35-25
COLLIN ANEL Pinça p/assepcia	13-07	CZEMY Espéculo retal	48-04
COLLIN CORAÇÃO Pinça p/assepcia	13-07		
		D	
		DANDY Pinça hemostática	13-02, 35-29
		DARTIGUES Pinça histerolabo	45-04

DAVIS			DIETRICH		
Afastador duplo		14-01	Clamp bulldog		30-08
Espátula cerebral		35-28	Tesoura cardiovascular		11-04, 30-30
DEAVER			DINKHUYSEN		
Afastador manual		14-09, 14-10	Cânula p/cardioplegia		30-25
DEBAKEY			DINKHUYSEN P/MAMARIA		
Clamp bulldog		30-08	Pinça dissecação		30-09
Clamp cardiovascular		30-09,30-11,30-12,30-13	DINKHUYSEN P/MAMARIA E MITRAL		
Clamp cardiovascular		30-14, 30-17, 30-17	Afastador		30-01
Pinça dissecação vascular		17-03, 30-28	DISSECÇÃO		
DEBAKEY 60°			C/Dente Standart		12-02
Clamp cardiovascular		30-21	C/Serrilha Standart		12-02, 30-10
DEBAKEY 90°			DOYEN		
Clamp cardiovascular		30-20	Pinça intestinal		48-01
DENNIS			Saca fibroma		45-03
Pinça dissecação c/anel		30-09	Valva vaginal		14-07, 45-02
DENNIS BROWNE			DR. ALENCAR		
Afastador circular		14-07	Descolador/aspirador nasal		51-05
DERRA			DRILL		35-04
Clamp cardiovascular		30-13	DUCK BILL		
DESCOLADOR			Pinça goiva		20-05, 35-18
Aspirador Desmontável		51-05	DUVAL		
De Placa		30-24	Pinça intestinal		13-06
Fino		30-24			
DESJARDINS			E		
Pinça urológica		49-02	ESOPRO PARA PLÁSTICA NASAL		51-06
DESMARRES			ESPANHOLA		
Afastador manual		14-01	Pinça de redução óssea		20-09
DIEFFENBACH			ESPÁTULA MALEÁVEL		14-03
Clamp vascular		30-08			

ESPELHO DE LARINGE 52-05
EXTRATO DE CABEÇA DE FEMUR 20-23

F

FARABEU
Afastador (par) 14-04

FARABEU
Rugina 20-11, 35-25

FARABEU LAMBOTTE
Pinça óssea 20-08

FAURE
Pinça para biópsia 45-04
Pinça para histerectomia 13-04, 45-04

FERRIS SMITH KERRISON
Para afastador Caspar 35-04

FINOCHEITTO
Afastador de costelas 30-02, 30-03, 30-04
Porta Agulha 17-03, 30-30

FIO DE AÇO
Porta Agulha 20-03

FOERSTER
Pinça p/ assepcia 13-07

FOMON
Tesoura nasal 11-04, 51-09, 60-02

FOMON ACOTOVELADA SERRILHADA
Tesoura nasal 11-04, 51-09, 60-02

FOWLER
Descolador serrilhado 52-06

FOX
Cureta dermatológica 40-01

FRAZIER
Cânula de aspiração 16-02, 35-13
Dissector 35-23
Tesoura para neuro 11-05, 35-35

FEER
Bisturi para septo 51-05
Descolador duplo 51-05

FUKUDA
Afastador para ombro 20-23

G

GANCHO DUPLO
Para plástica 20-15, 51-01, 60-10

GANCHO P/ CERUMEM 50-02
GANCHO P/ MAMA C/ ARGOLA 14-03
GANCHO P/ SIMPATECTOMIA 30-25

GARDNER
Trator cranial 35-36

GELPI
Afastador auto estático 14-14, 30-06

GEMINI
Pinça hemostática 13-03, 30-06

GERALD
Pinça dissecação 12-03

GERALD DEBAKEY
Pinça atraumática 12-03

GILLIES
Gancho delicado 14-02, 40-01, 60-10

GLENÓIDE
Afastador para ombro 20-23

GLOVER
Clamp cardiovascular 30-11

GLUCK Costótomo	20-03, 30-07	HENLEY Afastador	14-06, 30-04
GORNEY Tesoura	11-12	HENNING Abridor de gesso	20-01
GOSSET Afastador abdominal	14-13	HEYMANN Tesoura	11-05, 51-09, 60-02
GREGORY Clamp cardiovascular	30-13	HIBBS Osteóromo	20-15
GUIA DO DRILL Para afastador Caspar	35-04	HOEN Dissector para neuro Rugina	35-23 35-25
GUYON Dilatador urológico	49-04	HOHMANN Elevador ósseo	20-17, 20-18, 20-19
H			
HALSTEAD HARTMANN Pinça hemostática	13-01	HOKE Osteótomo	20-15
HALSTEAD MOSQUITO Pinça hemostática	13-01	HOUSE-DIETER Pinça p/biópsia auricular	50-03
HARDY Espéculo para neuro	35-28	HUDSON Fresa p/trépano Prolongador p/trépano Trépano manual	35-34, 35-36 35-34 35-34
HARRINGTON Afastador	14-06	HUNT Pinça p/tumor	35-33
HARTMANN Espéculo auricular Espéculo nasal Pinça para pólipos auriculares Pinça para pólipos nasais Pinça jacaré auricular Pinça para corpo estranho nasal	50-01 51-01 50-02 51-03 50-03 51-03	HUPE Saca comedão	40-02
HEANEY Porta agulha	17-03, 45-06	HURD Descolador p/amígdalas	52-05
HEGAR Dilatador uterino	45-03	I	
		INTERMEDIARIO Para micro aspirador auricular	50-01
		IRIS Tesoura	11-05, 60-03

IRIS GRAEFE			KILLIAN	
Pinça dissecação	12-03		Espéculo auricular	50-01
			Espéculo nasal	51-02
ISRAEL			KILNER	
Afastador	14-11		Tesoura	11-06, 60-04
ITARD			KIRKLIN	
Sonda auricular	50-02		Afastador	14-01, 30-05
		J	KOCHER	
JACARÉ			Pinça hemostática	13-05
Micro pinça auricular	50-03		Pinça intestinal	13-05, 48-02
JACOBSON			KOCHER LANGENBECK	
Gancho p/corpo estranho	50-02		Afastador	14-06
JANSEN			KOGAN	
Afastador	14-14		Pinça especulo vaginal	45-05
Pinça baioneta	12-03, 33-33		KRAYENBÜHL	
Pinça baioneta bipolar	60-07		Gancho p/nervos	35-26
JAVID				L
Clamp p/carótida	30-11		LAMBERT-KAY	
JENNINGS			Clamp cardiovascular	30-17
Abre-boca	55-01		LAMBOTTE	
JOSEPH			Osteótomo	20-16, 35-16
Gancho simples	14-02, 60-10		Pinça óssea	20-07
Raspa nasal	51-08		Rugina	20-12, 35-26
Rugina	35-25, 51-05		LANE	
Tesoura	11-06, 60-03		Pinça óssea	20-08
		K	LANGENBECK	
KATSCH			Rugina	20-12, 35-26, 60-09
Saca comedão	40-02		LANGENBECK MINI	
KELLY			Afastador	14-03
Pinça hemostática	13-02		LEBSCHÉ	
Pinça hemostática revestida	60-08		Faca para esterno	30-07

LEKSELL			MAGIL	
Pinça goiva	20-05, 35-18		Pinça para introduzir cateter	13-06
LELAND-JONES			MAINGOT	
Clamp cardiovascular	30-14		Pinça para histerectomia	45-05
LEWIN			MALIS	
Pinça de redução óssea	20-07		Gancho para nervos	35-28
LEYLA			MALTZ	
Afastador cerebral	35-05		Raspa nasal	51-08
LISTER			MARTEL	
Tesoura para gesso	11-06, 20-01		Passador para serra	35-15
LISTON			Pinça para couro cabeludo	13-06, 60-07
Cizalha	20-06, 35-19		MARTELO UNIVERSAL	20-22, 30-07
LISTON KEY			MASING	
Cizalha	20-06, 35-19		Descolador duplo nasal	51-05
LONGUETE			MATHIEU	
Pinça hemostática revestida	60-08		Especulo retal	48-03
Pinça hemostática	13-02, 30-25		Pinça para biópsia uretral	49-03
LOVE			Pinça para corpo estranho	49-03
Afastador p/nervos	14-01, 35-07		Porta agulha	17-04
LOVE GRUENWALD			MATOX	
Pinça p/laminectomia	35-32		Clamp cardiovascular	30-19
LOWMANN			MAYFIELD	
Pinça óssea	20-09		Suporte de Cranio	35-36
LUCAE			MAYO ADAMS	
Pinça baioneta	12-03, 50-02		Afastador	14-15
LUCY MAGALHAES			MAYO BUNT	
Saca comedão	40-02		Clip porta pinças	15-02
LUER			MAYO HARRINGTON	
Pinça goiva	20-03, 35-17		Tesoura	11-07
			MAYO HEGAR	
			Porta agulha	17-02, 30-28

M

MAYO STILLE Tesoura	11-07	MOYNIHAN Pinça hemostática	13-03, 30-26
MC INDOE Tesoura	11-07, 51-10, 60-04	MUSEUX Pinça para colo uterino	45-05
MC IVOR Abre-boca	52-01	N	
MC KENZIE Pinça aplicadora de clip	35-29	NEGUS Pinça hemostática	13-03
MEAD Martelo	20-22, 51-09	NELSON Pinça dissecação	12-04
METZEMBAUM Tesoura	11-08	NEVES PINTO Descolador duplo nasal	51-05
MEYERDING Afastador	14-02	NICOLA Pinça para biópsia	35-33
MICRO PINÇA MICRO PORTA AGULHA MICRO TESOURA PARA MICROCIRURGIA	62-03, 62-04, 62-05, 62-06 62-06 62-01, 62-02	NORTE-SUL Afastador ortopédico	20-02
MIDLETON JANSEN Pinça cortante nasal	51-04	NOVAK Cureta aspiradora uterina	45-07
MIELOGRAMA Agulha	16-01	O	
MILLIGAN Dissector	35-23	OBWEGESER Afastador para buco maxilo facial Agulha	55-01 55-02
MILLIN Afastador urológico	49-01	OLIVECRONA Dissector duplo Tesoura para neurocirurgia	35-23 11-09, 35-34
MIXTER Pinça hemostática	13-03, 30-26, 52-04	OLLIER Afastador	14-11
MOLDENHAUER Gancho auricular	50-02	ORDENHA Pinça	30-26
MOLT Abre-boca	55-01		

ORELHA DE ABANO Kit para plástica	60-10	PORTA AGULHAS PARA FIO DE AÇO	17-03, 30-28, 55-02
P		PORTA ALGODÃO Com argola maleavel	15-02
PARKER Afastador (par)	14-04	Com cabo e rosca	15-02
PARTSCH Martelo	20-22, 51-09	POTTS Clamp cardiovascular	30-15, 30-16
PAYR Pinça clamp intestinal	48-01	POTTS SMITH Pinça disseção	12-01, 12-04, 30-10
PEAN MURPHY Pinça para assepcia	13-08	Tesoura cardiovascular	11-15, 30-31
PEET Raspa nasal	51-08	POZZI Pinça para colo uterino	45-05
PENFIELD Dissector	35-24	PROF. MEDINA Pinça para biópsia ginecológica	45-05
PENN Gancho duplo	14-03, 51-01, 60-10	PUNCH / PUNCH DERMATOLÓGICO Punch dermatológico	40-01
PENNINGTON Pinça hemostática	13-05	R	
PERFURADOR MANUAL	35-29	RANDALL Pinça para cálculo renal	49-02
PETEAN Pinça para varizes	30-27	RASTELO Gancho	60-11
PINÇA REDUÇÃO ÓSSEA	20-09	RECAMIER Cureta ginecológica	45-08
PITANGA Anuscópio	48-04	REES Tesoura	11-16, 60-04
PITANGUY Pinça de marcação para plástica	60-07	REVERDIN Espátula baioneta	14-04
POLITZER Faca para paracentese	50-02	REYNOLD Pinça para tubo	13-08
POOLE Cânula de aspiração	16-02	Tesoura	11-11, 30-27, 60-05
		RHOTON Micro dissectores	35-27

ROCHESTER PEAN Pinça hemostática	13-04	SCOVILLE Afastador	35-10, 35-12
ROWE Pinça de redução nasal	55-02	SCOVILLE HAVERFIELD Afastador	35-10
RUMEL Passa fio	30-25	SEMB Pinça óssea	20-07
RUSKIN Cizalha	20-06	Pinça para ligadura	30-28
RUSSA PATA DE GATO Pinça dissecação	12-04	Rugina	20-13
RYDER Porta agulha	17-04, 30-29	SEMKEN Pinça dissecação	12-01
		SENN MULLER Afastador duplo	14-01
S		SERINGA PAVAGEM DE OUVIDO	50-01
SACA BOCADO Micro pinça auricular	50-04	SERRA DE GIGLI	35-15
SACA TROMBO Pinça vascular	30-28	SERRA NÓ EVES	52-03
SACHS Dissector para neuro	35-23	SERRA NÓ SAGE TIPO REVOLVER	52-03
SATINSKY Clamp cardiovascular	30-22	SIMON Cureta	20-21, 35-21
SAUERBRUCH Afastador	14-07	SIMS Cureta	48-03
SCALP Afastador auto estático	14-14, 35-09	Tesoura	11-11
SCHNIDT Pinça hemostática	13-04, 30-26, 52-04	SINGLEY TUTTLE Pinça dissecação	12-04
SCHROEDER Cureta uterina	45-08	SMITH Fresa para trépano	35-36
SCOOBE ALLIS Pinça para amigdalectomia	52-04	SMITH PETERSEN Osteótomo	20-16
		SOFIELD Afastador	14-04, 20-02
		SPENCER Tesoura para ponto	11-12, 60-05
		SPERLI Raspa nasal	51-08

SPING Afastador	14-13	THOMSOM WALKER Afastador urológico	49-01
SPRATT Cureta	20-21, 35-21	TOBOLD Abaixa língua	52-02
STANDART Costótomo	20-03, 30-07	TOENNIS Dissector	35-23
STEVENS Tesoura	11-10, 60-05	U	
STILLE Osteótomo	20-17	ULRICH Pinça óssea	20-10
STILLE LISTON Cizalha	20-07, 35-20	UNIVERSAL Tesoura para fio de aço Afastador	11-10, 20-01 14-19 até 14-22
STILLE LUER Cizalha	20-05, 35-18	V	
STRULLY Tesoura	11-10	VALVULA MITRAL Afastador cardiovascular	30-05
STRUYCKEN Pinça cortante nasal	51-04	VÁLVULA MITRAL Pinça cardiovascular	30- 27
T		VASCULAR Porta agulha	17-04, 30-29
TAKAHASHI Pinça cortante nasal	51-04	VICKERS Martelo em nylon	20-22
TAYLOR Elevador ósseo Tesoura	20-14, 35-13 11-12, 35-34	VOLKMANN Afastador	14-08, 20-20
TENTACÂNULA	15-02	W	
TESOURA CIRÚRGICA	11-03	WALSHAM Pinça de redução nasal	51-01
TESOURA PARA CORTAR		WEIL-BLAKESLEY Pinça cortante nasal	51-04
TUBOS SERRILHADA	11-09, 30-31		
THOMS GAYLOR Pinça para biópsia	45-06		
THOMSOM WALKER Afastador urológico	49-01		

WEITLANER
Afastador 14-14, 30-06, 35-13

WERTHEIM
Pinça para peritônio 45-06

WERTHEIM-CULLEN
Pinça para histerectomia 45-06

WINTER
Pinça para aborto e placenta 45-07

WOLFF
Pinça para gesso 20-01

Y

YANKAUER
Cânula de aspiração 16-02

YASARGIL
Haste para afastador Leyla 35-06
Micro tesoura baioneta 35-36
Pinça baioneta delicada 35-35
Pinça para tumor 35-33

Z

ZAUFAL-JANSEN
Pinça goiva 20-04, 35-16



LANG ELETRO MEDICINA LTDA.

Rua Joaquim Vieira Filho, 562 - Japuíba - Cachoeiras de Macacu - RJ

Tel: (21) 3539-0660 / 3539-0650 - Fax: (21) 3539-0666

www.lang.com.br

Lang[®]
Desde 1926

