

**LANG**<sup>®</sup>  
Desde 1928



**Ortopedia e Cirurgia Óssea**



23 CM  
20-018-23

PINÇA  
WOLFF



28 CM  
20-012-28

HENNING  
ABRE-GESSO



17 CM - 11-192-17  
20 CM - 11-192-20

SERRILHADA  
17 CM - 11-192-17S  
20 CM - 11-192-20S

TESOURA  
LISTER

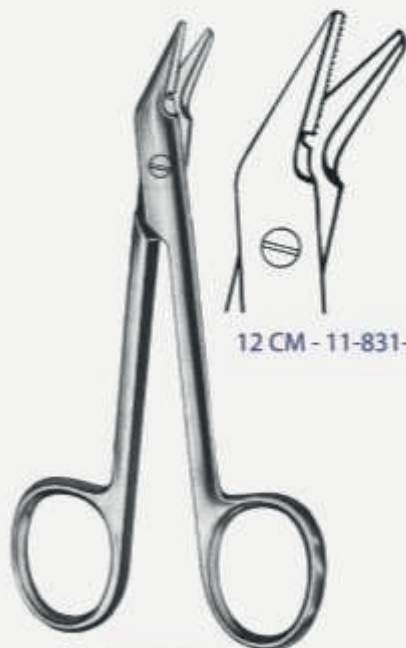

12 CM - 11-831-12

TESOURA  
UNIVERSAL  
P/ FIO DE AÇO

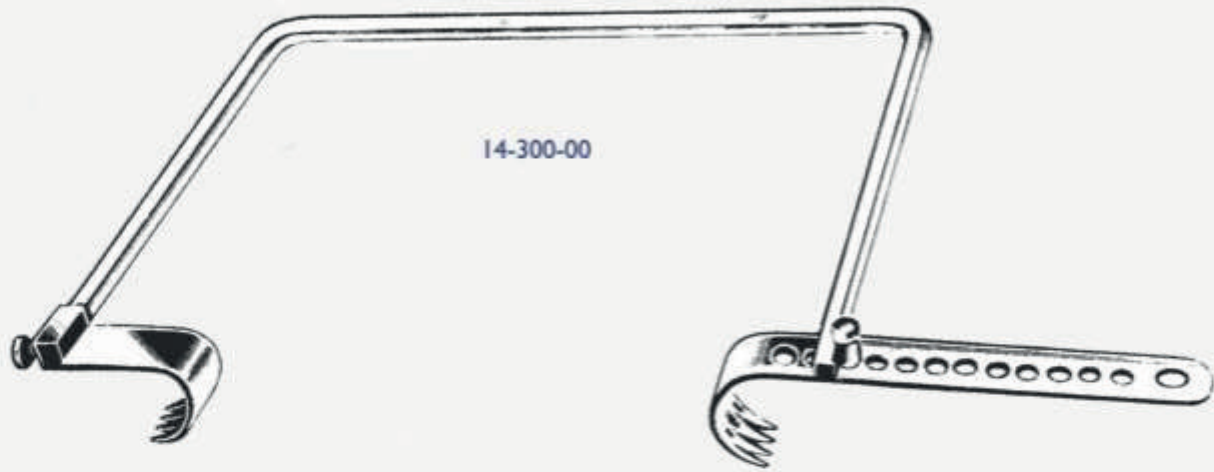

14-300-00

AFASTADOR  
NORTE-SUL



JOGO COMPLETO  
20-020-06

- 150 X 45 X 35 - 20-020-15
- 160 X 60 X 45 - 20-020-16
- 170 X 65 X 55 - 20-020-17
- 180 X 85 X 60 - 20-020-18
- 190 X 100 X 65 - 20-020-19
- 200 X 115 X 75 - 20-020-20

AFASTADOR  
SOFIELD



14 CM - 20-036-14  
18 CM - 20-036-18

**BAILEY**  
APROXIMADOR DE  
COSTELAS



18 CM  
17-120-18W  
20 CM  
17-120-20W

**PORTA AGULHA**  
P/ FIO DE AÇO



19 CM - 20-102-19  
22 CM - 20-102-22

**COSTÓTOMO**  
GLUCK



22 CM - 20-120-22

**COSTÓTOMO**  
STANDART



18 CM  
20-463-18

**PINÇA GOIVA**  
LUER RETA



18 CM  
20-462-18

**PINÇA GOIVA**  
LUER CURVA



18 CM  
20-421-18

**PINÇA GOIVA  
BEYER RETA**



18 CM  
20-420-18



**PINÇA GOIVA  
BEYER CURVA**



18 CM  
20-473-18

**PINÇA GOIVA  
ZAUFAL-JANSEN**

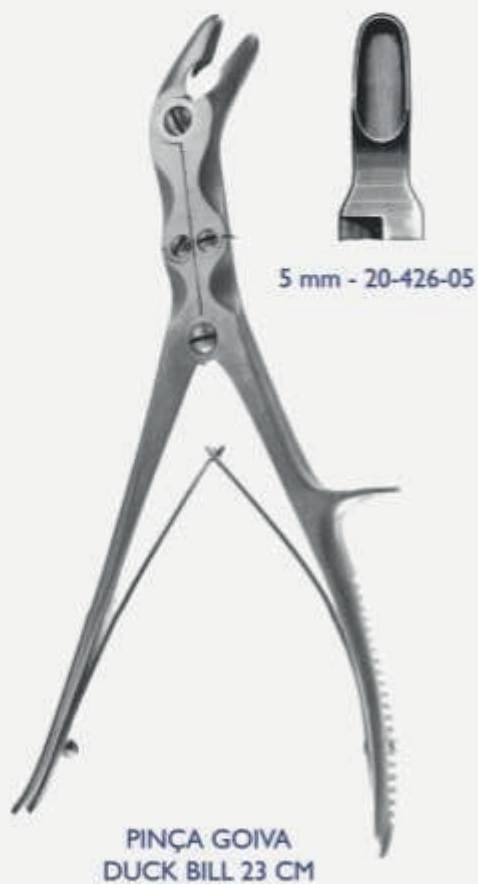
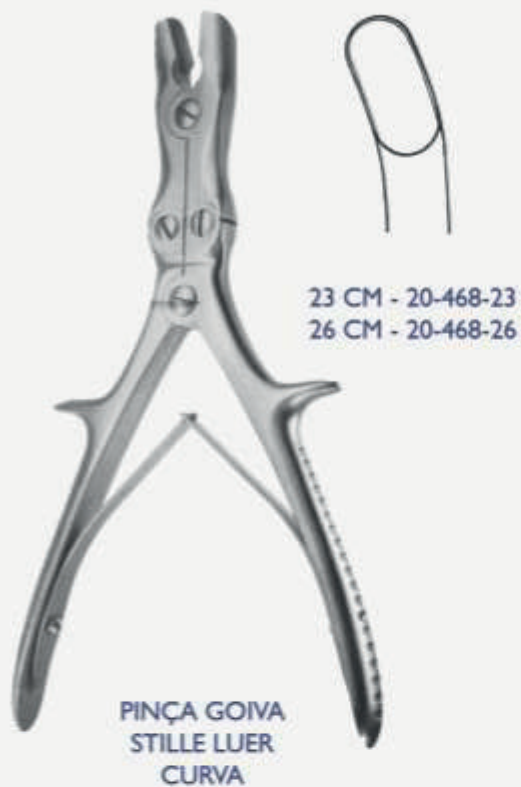

# ORTOPEDIA E CIRURGIA ÓSSEA



14 CM  
20-061-14  
19 CM  
20-061-19



14 CM  
20-060-14  
19 CM  
20-060-19



CIZALHA LISTON  
RETA

CIZALHA LISTON  
CURVA



27 CM  
35-039-27

CIZALHA  
LISTON KEY



18 CM  
20-073-18

CIZALHA  
RUSKIN RETA

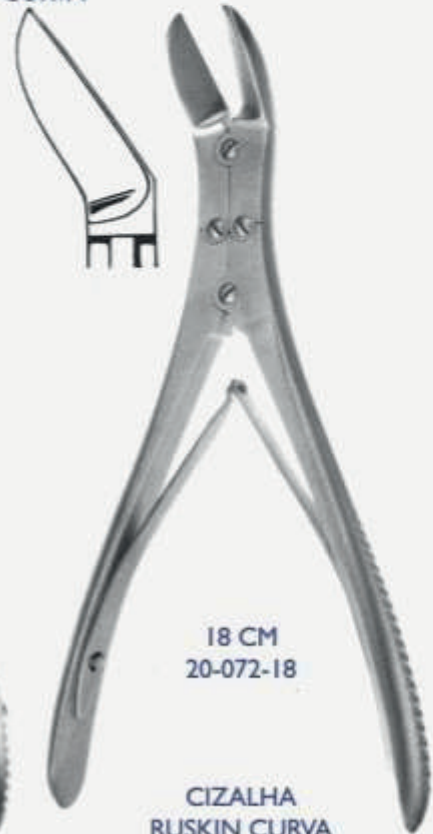

18 CM  
20-072-18

CIZALHA  
RUSKIN CURVA



CIZALHA  
STILLE LISTON  
RETA



23 CM - 20-079-23  
27 CM - 20-079-27



CIZALHA  
STILLE LISTON  
CURVA



23 CM - 20-078-23  
27 CM - 20-078-27

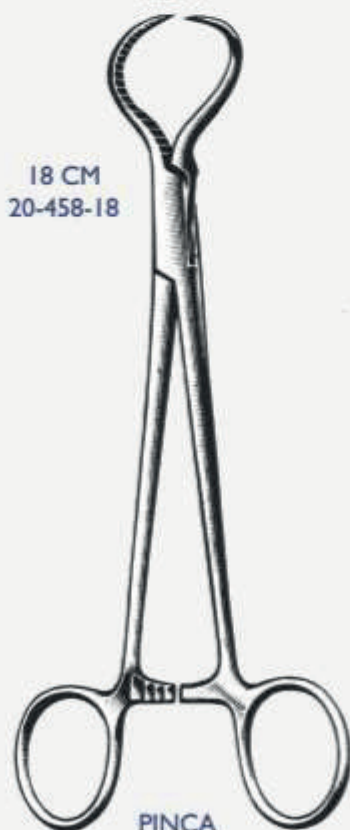

18 CM  
20-458-18

PINÇA  
LEWIN



20 CM  
20-886-19

PINÇA  
SEMB



21 CM - 20-438-21  
26 CM - 20-438-26  
31 CM - 20-438-31

PINÇA  
LAMBOTTE  
C/ CREMALHEIRA





26 CM  
20-434-26

FARABEU  
LAMBOTTE S/ CREMALHEIRA



26 CM  
20-432-26

FARABEU  
LAMBOTTE C/ CREMALHEIRA



22 CM - 20-452-22  
27 CM - 20-452-27  
33 CM - 20-452-33

LANE S/CREMALHEIRA



22 CM - 20-450-22  
27 CM - 20-450-27  
33 CM - 20-450-33

LANE C/CREMALHEIRA

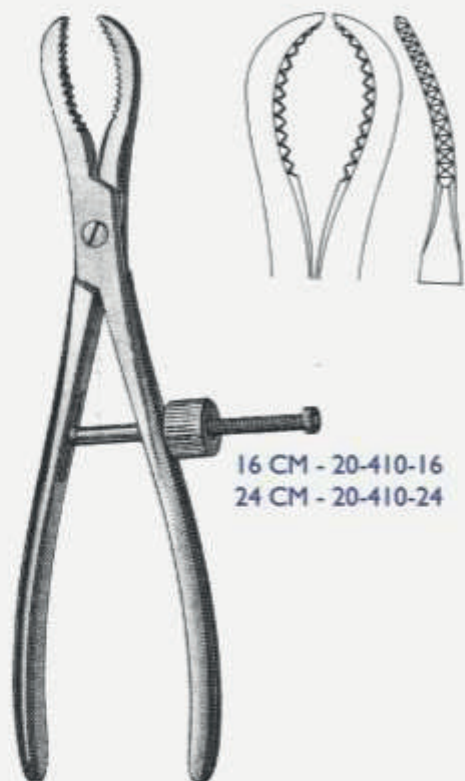

16 CM - 20-410-16  
24 CM - 20-410-24

PINÇA  
ESPANHOLA

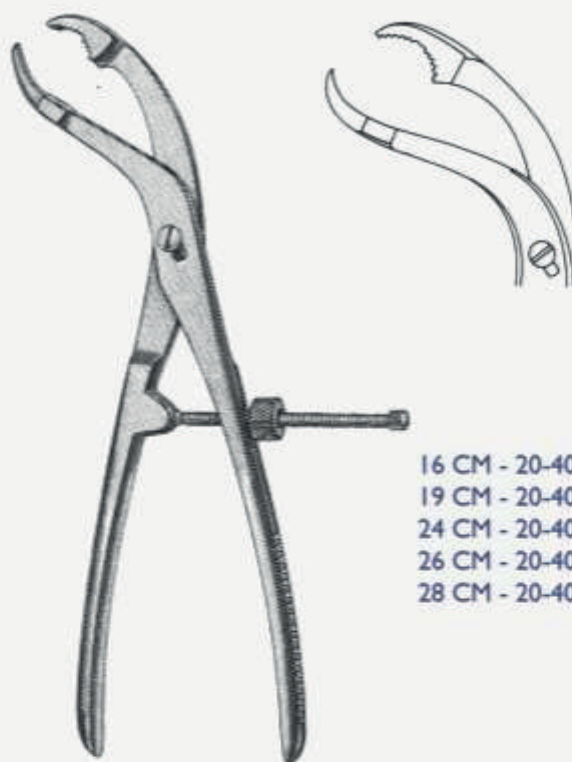

16 CM - 20-400-16  
19 CM - 20-400-19  
24 CM - 20-400-24  
26 CM - 20-400-26  
28 CM - 20-400-28

PINÇA  
AUTO CENTRANTE



14 CM - 20-460-14  
16 CM - 20-460-16  
18 CM - 20-460-18  
20 CM - 20-460-20  
22 CM - 20-460-22

PINÇA LOWMANN



13 CM  
20-465-13

PINÇA REDUÇÃO ÓSSEA  
C/PONTA

# ORTOPEDIA E CIRURGIA ÓSSEA



23 CM - 20-415-23  
25 CM - 20-415-25  
28 CM - 20-415-28

PINÇA  
ULRICH

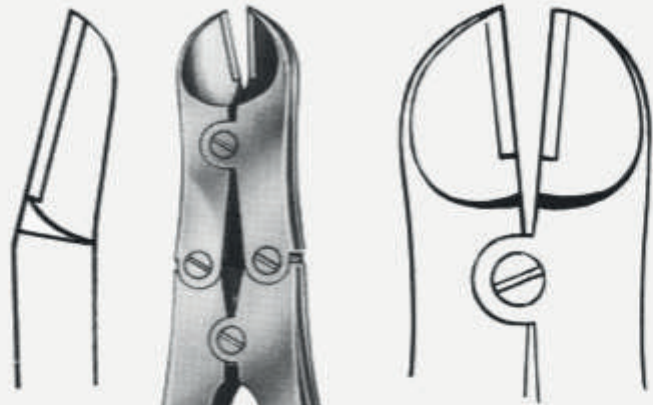

WÍDIA  
17 CM - 20-024-17W  
21 CM - 20-024-21W  
23 CM - 20-024-23W



WÍDIA  
21 CM  
20-024-21W

ALICATE  
CORTE LATERAL  
DUPLA FORÇA

ALICATE  
CORTE LATERAL  
DUPLA FORÇA

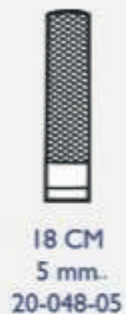

ALICATE P/  
EXTRAÇÃO DE FIO  
DE AÇO



ALICATE PARALELO DE CORTAR  
E PUXAR FIO INOX

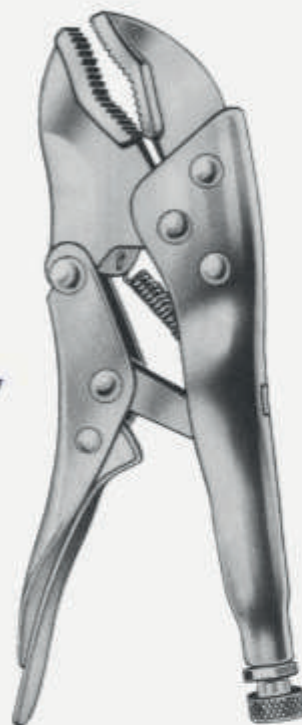

18 CM  
20-028-18

ALICATE DE  
PRESSÃO INOX



RUGINA  
FARABEU F RETA



15 CM  
20-481-16



RUGINA  
FARABEU F CURVA



15 CM  
20-480-16

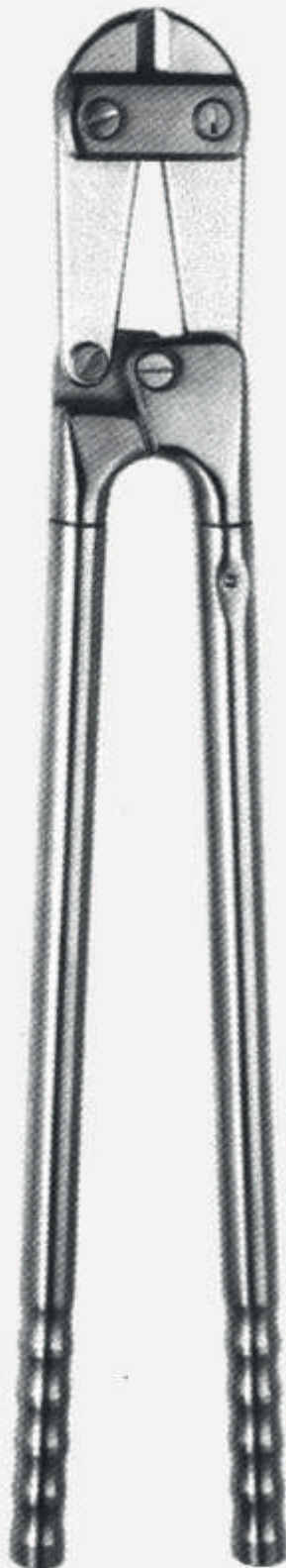

ALICATE  
RICARDÃO  
AÇO INOX  
CABO REMOVÍVEL

WÍDIA  
58 CM - 20-028-58W



RUGINA  
LAMBOTTE  
21 CM



10 mm - 20-492-10  
15 mm - 20-492-15  
20 mm - 20-492-20



15 mm  
20-498-01  
20-499-15

RUGINA  
LANGENBECK  
19 CM



**RUGINA  
SEMB**



**N° 1**  
12 mm X 20,5 CM  
20-600-01



**N° 2**  
12 mm X 24 CM  
20-600-02



**N° 3**  
13 mm X 24 CM  
20-600-03



**N° 4**  
13 mm X 24 CM  
20-600-04



**N° 5**  
13 mm X 23 CM  
20-600-05



**N° 6**  
14 mm X 24 CM  
20-600-06

# ORTOPEDIA E CIRURGIA ÓSSEA



24 CM X 43 mm  
20-258-43

24 CM X 60 mm  
20-258-60

BENNET



17.5 CM  
20-264-18



BLOUNT



25 CM  
20-266-02

BLOUNT DUPLA



27 CM  
20-266-01

BLOUNT SIMPLES



075 X 30 mm - 20-306-75  
100 X 30 mm - 20-306-10

TAYLOR



RUGINA  
COBB



25 CM  
19 mm - 20-700-19



25 CM  
25 mm - 20-700-25



OSTEÓTOMO  
HOKE RETO

JOGO  
20-490-00

- 14 CM  
03 mm - 20-490-03  
04 mm - 20-490-04  
06 mm - 20-490-06  
10 mm - 20-490-10  
12 mm - 20-490-12



OSTEÓTOMO HIBBS RETO

JOGO  
20-320-00

- 24 CM  
06 mm - 20-320-06  
12 mm - 20-320-12  
16 mm - 20-320-16  
18 mm - 20-320-18  
22 mm - 20-320-22  
25 mm - 20-320-25  
32 mm - 20-320-32



OSTEÓTOMO HIBBS CURVO

JOGO  
20-321-00

- 24 CM  
06 mm - 20-321-06  
12 mm - 20-321-12  
16 mm - 20-321-16  
18 mm - 20-321-18  
22 mm - 20-321-22  
25 mm - 20-321-25  
32 mm - 20-321-32





**LAMBOTE  
23 CM**

06 mm - 20-331-06  
10 mm - 20-331-10  
15 mm - 20-331-15  
20 mm - 20-331-20  
25 mm - 20-331-25  
30 mm - 20-331-30

**MINI LAMBOTE  
17CM**

06 mm - 20-333-06  
10 mm - 20-333-10  
15 mm - 20-333-15  
20 mm - 20-333-20  
25 mm - 20-333-25  
30 mm - 20-333-30

**OSTEÓTOMO  
LAMBOTTE  
RETO**



**LAMBOTE  
23 CM**

06 mm - 20-330-06  
10 mm - 20-330-10  
15 mm - 20-330-15  
20 mm - 20-330-20  
25 mm - 20-330-25  
30 mm - 20-330-30

**MINI LAMBOTE  
17CM**

06 mm - 20-332-06  
10 mm - 20-332-10  
15 mm - 20-332-15  
20 mm - 20-332-20  
25 mm - 20-332-25  
30 mm - 20-332-30

**OSTEÓTOMO  
LAMBOTTE  
CURVO**



**LAMBOTE  
23 CM**

06 mm - 20-073-06  
09 mm - 20-073-09  
12 mm - 20-073-12  
15 mm - 20-073-15  
20 mm - 20-073-20  
25 mm - 20-073-25  
30 mm - 20-073-30

**OSTEÓTOMO  
SMITH PETERSEN**



20 CM  
08 mm - 20-354-08  
10 mm - 20-354-10  
12 mm - 20-354-12  
15 mm - 20-354-15  
20 mm - 20-354-20  
25 mm - 20-354-25



20 CM  
08 mm - 20-355-08  
10 mm - 20-355-10  
12 mm - 20-355-12  
15 mm - 20-355-15  
18 mm - 20-355-18  
22 mm - 20-355-22

OSTEÓTOMO  
STILLE DUPLO  
BIZEL

STILLE GOIVA

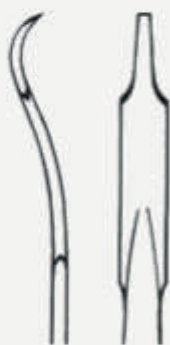

16 CM  
6 mm - 20-300-00

ELEVADOR  
MINI HOHMANN



16 CM  
8 mm - 20-302-00

ELEVADOR  
MINI HOHMANN



24 CM  
08 mm - 20-300-01  
PONTA FINA

ELEVADOR  
HOHMANN



24 CM  
18 mm - 20-300-02  
PONTA FINA

ELEVADOR  
HOHMANN



24 CM  
33 mm - 20-300-02  
PONTA CHATA

ELEVADOR  
HOHMANN

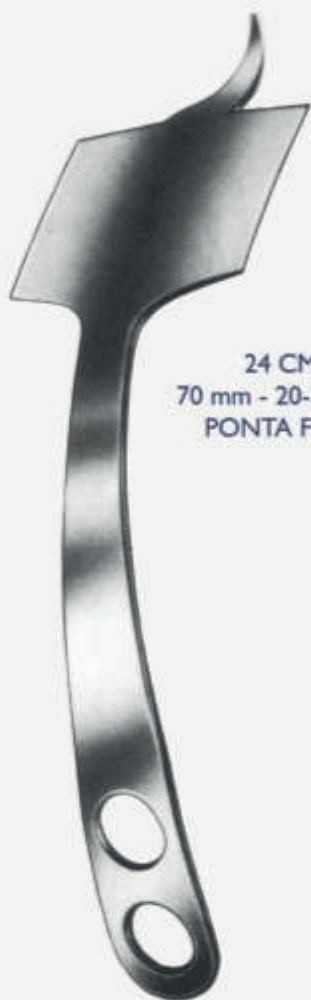

24 CM  
70 mm - 20-300-06  
PONTA FINA

ELEVADOR  
HOHMANN



24 CM  
43 mm - 20-300-05  
PONTA FINA

ELEVADOR  
HOHMANN



24 CM  
22 mm - 20-300-03  
PONTA CHATA

ELEVADOR  
HOHMANN

# ORTOPEDIA E CIRURGIA ÓSSEA



CURETA  
BRUNS  
17 CM



N° 000  
20-180-30



N° 00  
20-180-20



N° 0  
20-180-10



N° 1  
20-180-01



N° 2  
20-180-02



N° 3  
20-180-03



N° 4  
20-180-04



N° 5  
20-180-05



N° 6  
20-180-06



CURETA VOLKMANN  
17 CM



N° 0000  
20-151-40



N° 000  
020-151-30



N° 00  
020-151-20



N° 0  
020-151-10



N° 1  
020-151-01



N° 2  
020-151-02



N° 3  
020-151-03



N° 4  
020-151-04



N° 5  
020-151-05



N° 6  
020-151-06



CURETA  
SIMON  
23 CM



CURETA  
SPRATT  
18 CM





320G  
20-372-32

MARTELO MEAD C/CABEÇAS  
INTERCAMBIÁVEIS



350G - 20-380-35  
500G - 20-380-50  
750G - 20-380-75  
1000G - 20-380-10

MARTELO UNIVERSAL



120G - 20-384-12  
320G - 20-384-32

MARTELO  
VICKERS EXTREMIDADES  
EM NYLON



250G  
20-378-25

MARTELO  
PARTSCH



**AFASTADOR FUKUDA**  
35 mm - 20-510-00  
40 mm - 20-510-01



**AFASTADOR GLENÓIDE**  
LARGO - 20-511-20  
ESTREITO - 20-511-10



20-300-10

**AFASTADOR  
BENT-HOMANN**  
90°

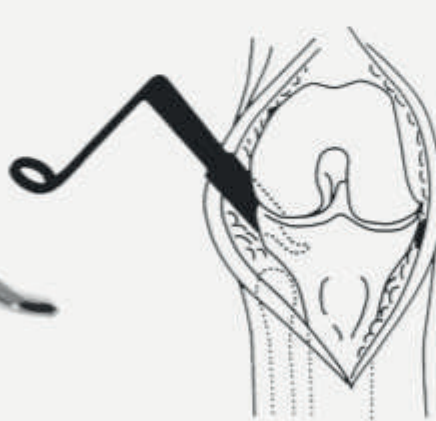





ADULTO  
20-110-01

INFANTIL  
20-111-01

ESTRIBO DE  
BOEHLER



20-500-00

EXTRATOR DE CABEÇA  
DE FÊMUR

Set emergencial para retirada de parafusos danificados ou quebrados nos ossos.

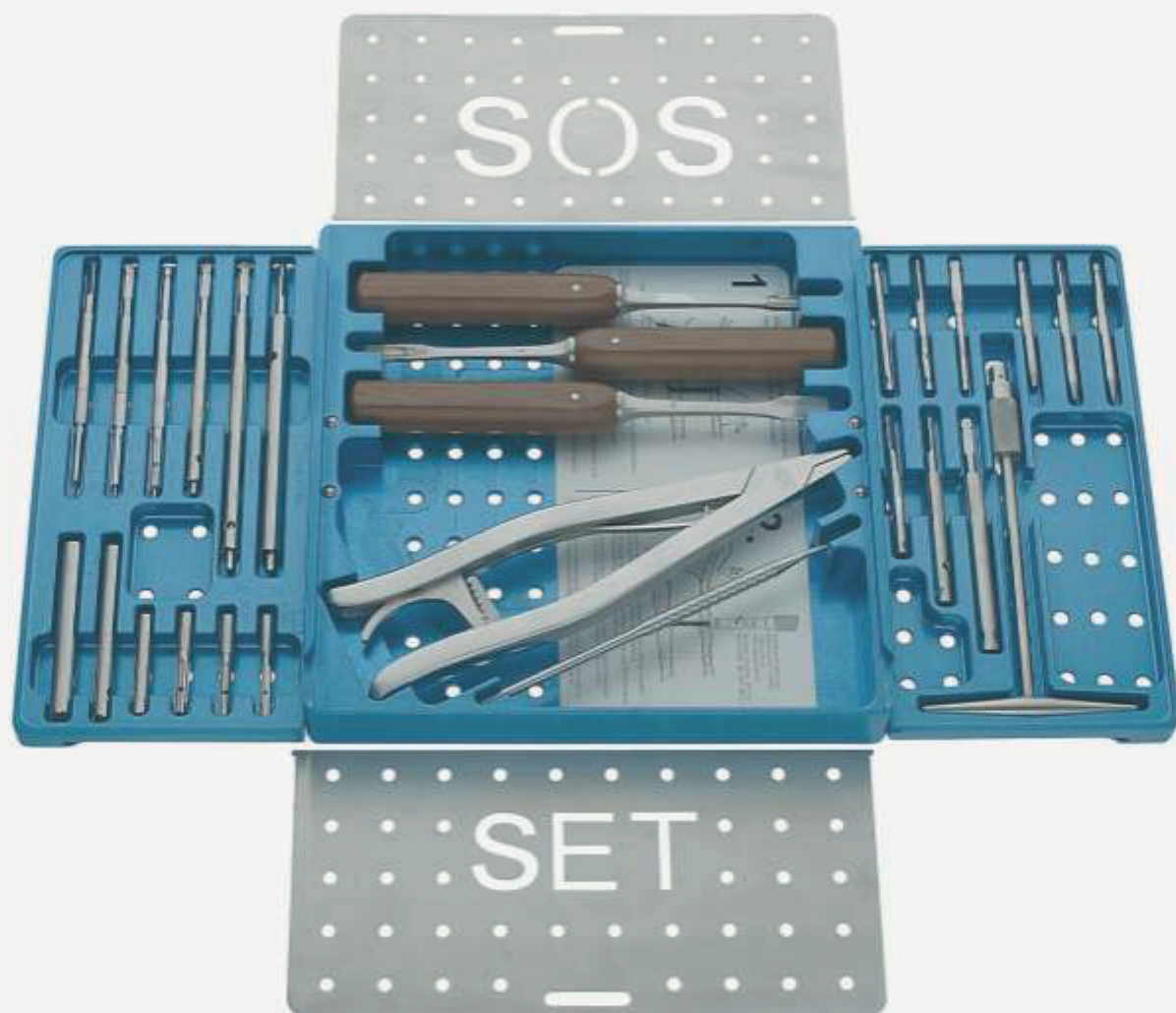

Acompanha dois templates de Alumínio com instruções para remover parafusos quebrados ou danificados.



SET DE REMOÇÃO  
COMPLETO

20-900-00

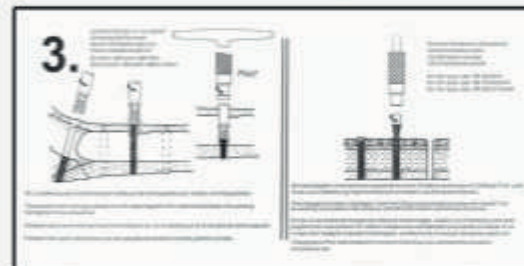
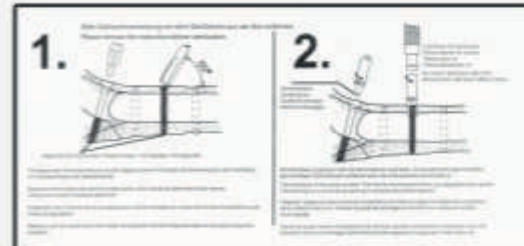

CONTAINER

CONTAINER PERFURADO  
COM FECHO PARA AUTOCLAVE

280 X 280 X 150MM - HE-1130-10  
480 X 280 X 150MM - HE-1130-13  
580 X 280 X 150MM - HE-1130-15



1,5 mm - 20-360-15  
2,0 mm - 20-360-20  
2,7 mm - 20-360-27  
3,5 mm - 20-360-35  
4,0 mm - 20-360-40  
4,5 mm - 20-360-45  
5,0 mm - 20-360-50  
6,5 mm - 20-360-65  
7,0 mm - 20-360-70

TREFINA OCA  
COMPLETA



1,5 mm - 20-100-15  
2,0 mm - 20-100-20  
2,7 mm - 20-100-27  
3,5 mm - 20-100-35  
4,0 mm - 20-100-40  
4,5 mm - 20-100-45  
5,0 mm - 20-100-50  
6,5 mm - 20-100-65  
7,0 mm - 20-100-70

EXTRATOR DE PARAFUSO  
QUEBRADO



160 mm  
20-123-10

CABO LANG EMT



10 mm  
20-000-10

GOIVA CÔNCAVA



6 mm  
20-000-06

GOIVA CÔNCAVA



4 mm  
20-000-04

GOIVA CÔNCAVA

# ORTOPEDIA E CIRURGIA ÓSSEA



20-111-30  
GANCHO/ERINA  
LANG



TREFINA OCA  
DE REPOSIÇÃO

1,5 mm - 20-361-15  
2,0 mm - 20-361-20  
2,7 mm - 20-361-27  
3,5 mm - 20-361-35  
4,0 mm - 20-361-40  
4,5 mm - 20-361-45  
5,0 mm - 20-361-50  
6,5 mm - 20-361-65  
7,0 mm - 20-361-70



PARAFUSOS DE  
EXTRAÇÃO CÔNICO

1,5 e 2,0 mm - 20-121-15  
2,7 - 3,5 e 4,0 mm - 20-121-27  
4,5 e 6,5 mm - 20-121-45



TREFINA PARA  
CENTRALIZAÇÃO  
DE PARAFUSO

1,5 mm - 20-365-15  
2,0 mm - 20-365-20  
2,7 mm - 20-365-27  
3,5 mm - 20-365-35  
4,0 mm - 20-365-40  
4,5 mm - 20-365-45  
5,0 mm - 20-365-50  
6,5 mm - 20-365-65  
7,0 mm - 20-365-70



CIZALHA  
ARTICULADA

20,5 CM  
20-121-20