





32 CM - 7 X 7  
14-048-32 AGUDO  
14-049-32 ROMBO

ADSON BECKMANN  
EATON



17 CM - 4 X 3  
14-041-17 AGUDO  
14-042-17 ROMBO

ADSON BECKMANN



31 CM - 4 X 4  
14-041-31 AGUDO  
14-042-31 ROMBO

ADSON BECKMANN



31 CM  
14-012-31 AGUDO  
14-013-31 ROMBO

ADSON



25 CM - 35-008-25

CLOWARD



45 mm - 35-086-45  
50 mm - 35-086-50  
55 mm - 35-086-55  
60 mm - 35-086-60



45 mm - 35-085-45  
50 mm - 35-085-50  
55 mm - 35-085-55  
60 mm - 35-085-60





12 mm - 35-013-12  
14 mm - 35-013-14  
16 mm - 35-013-16



PARAFUSO



DRILL

35-012-02



16 CM  
35-012-16D - DIREITO  
35-012-16E - ESQUERDO

CASPAR  
CORPO VERTEBRAL



35-012-01

CHAVE APLICADORA



DIREITO  
35-012-03D

GUIA DO DRILL



ESQUERDO  
35-012-03E

GUIA DO DRILL



35-012-04

APLICADOR DE ENXERTO

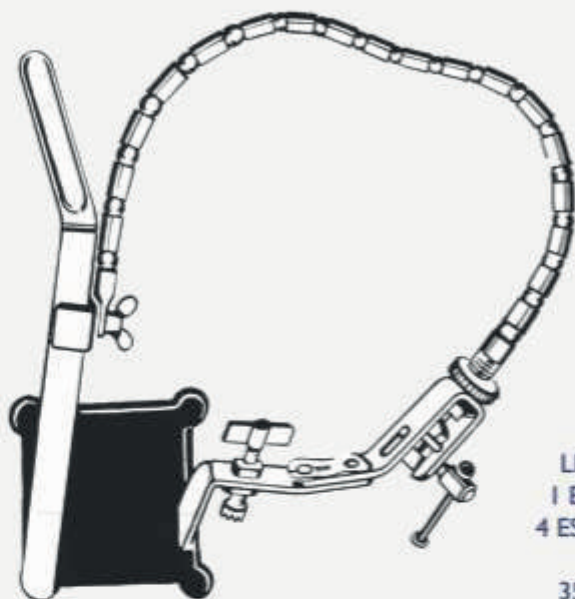

LEYLA C/  
1 BRAÇO E  
4 ESPÁTULAS

35-016-01

## Utilização do Afastador

Demonstração da utilização do  
afastador Leyla com 1 braço



Demonstração da utilização do  
afastador Leyla com 2 braços

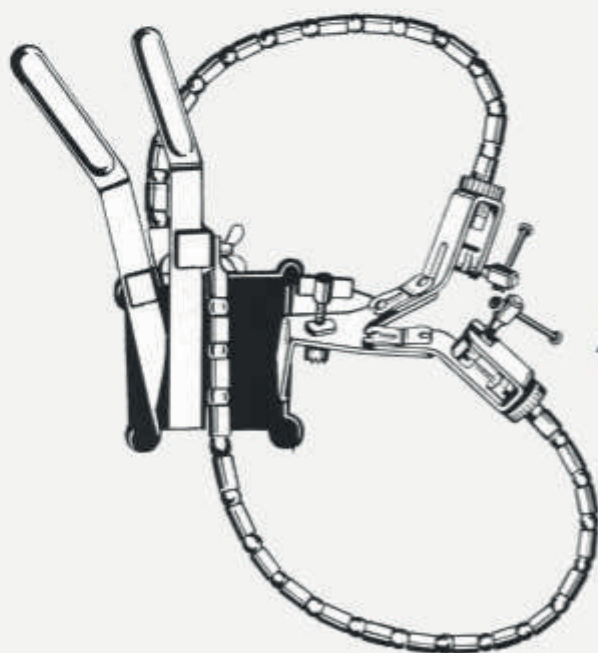

LEYLA C/  
2 BRAÇO E  
4 ESPÁTULAS

35-016-02



## Acessórios para montagem do afastador Leyla na mesa.

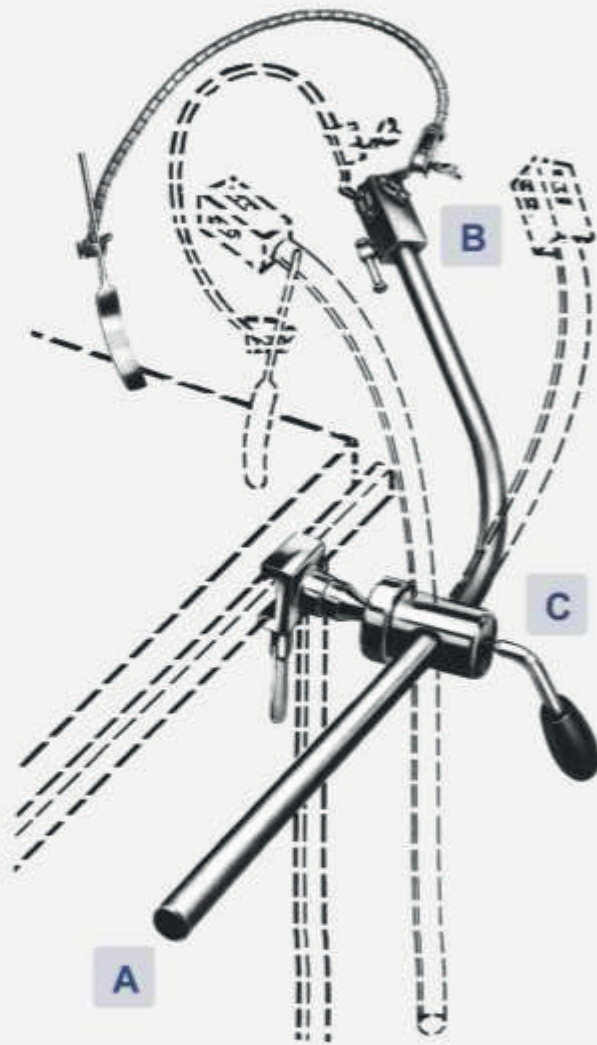

**A** Rígida fixação do braço.

**B** Cabeça aclopável para segurar até cinco braços flexíveis.

**C** Clamp para montagem, permitindo que o braço se mantenha rígido ao lado da mesa de operações.

35-074-00

HASTE YASAGIL  
P/ AFASTADOR LEYLA

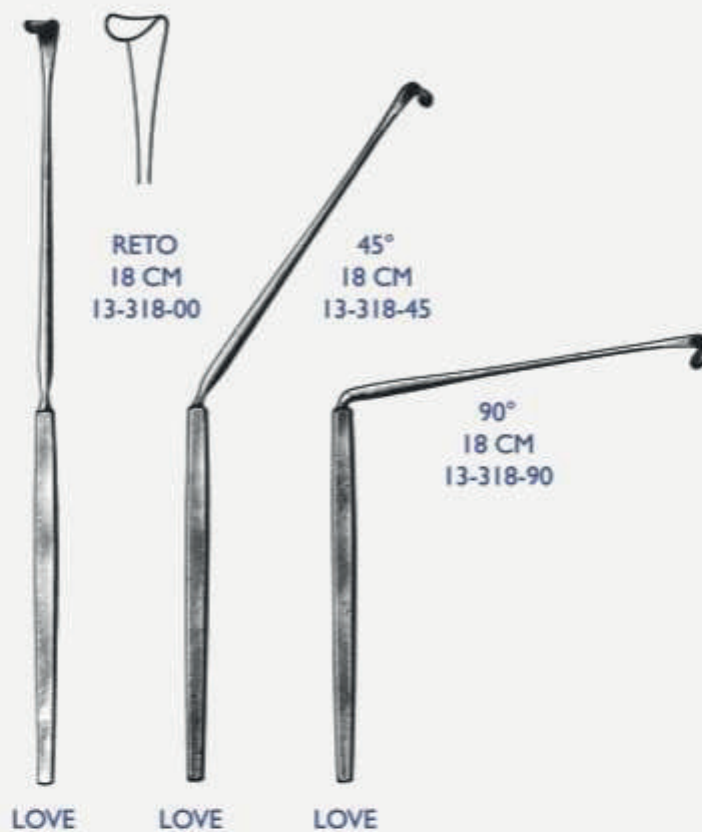

LADO ESQUERDO

17 CM  
14-321-17



LADO DIREITO

17 CM  
14-320-17



MARKHAN MEYERDING



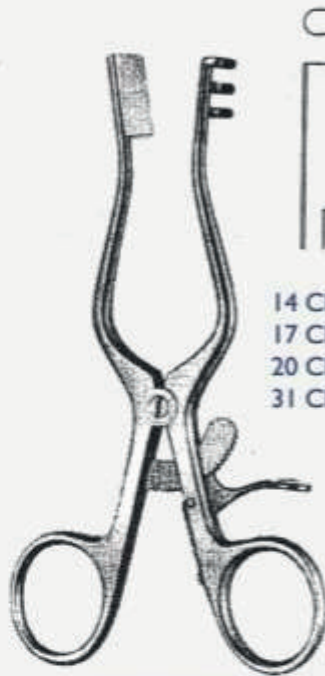

14 CM - 14-375-14  
17 CM - 14-375-17  
20 CM - 14-375-20  
31 CM - 14-375-31

MEYERDING  
ESQUERDO

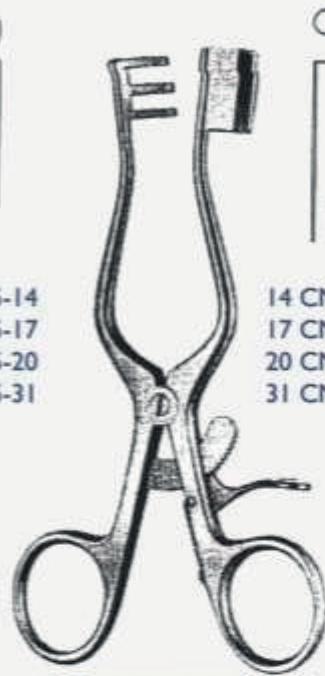

14 CM - 14-374-14  
17 CM - 14-374-17  
20 CM - 14-374-20  
31 CM - 14-374-31

MEYERDING  
DIREITO



17 CM - 14-362-17  
31 CM - 14-362-31

MEYERDING  
ESQUERDO



17 CM - 14-361-17  
31 CM - 14-361-31

MEYERDING  
DIREITO

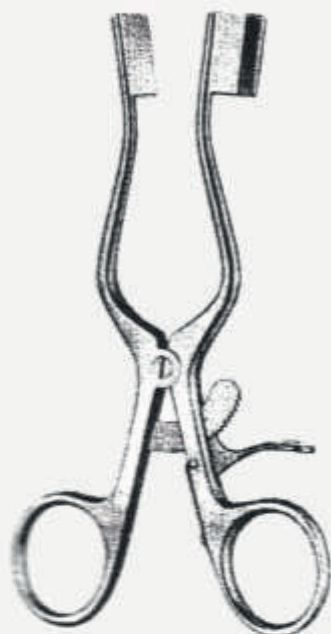

14 CM - 14-368-14  
17 CM - 14-368-17  
20 CM - 14-368-20  
31 CM - 14-368-31

MEYERDING  
DUPLO



17 CM - 14-360-17  
31 CM - 14-360-31

MEYERDING  
DUPLO ARTICULADO



AGUDO  
14 CM - 14-420-14  
16 CM - 14-420-16

ROMBO  
14 CM - 14-421-14  
16 CM - 14-421-16

SCALP

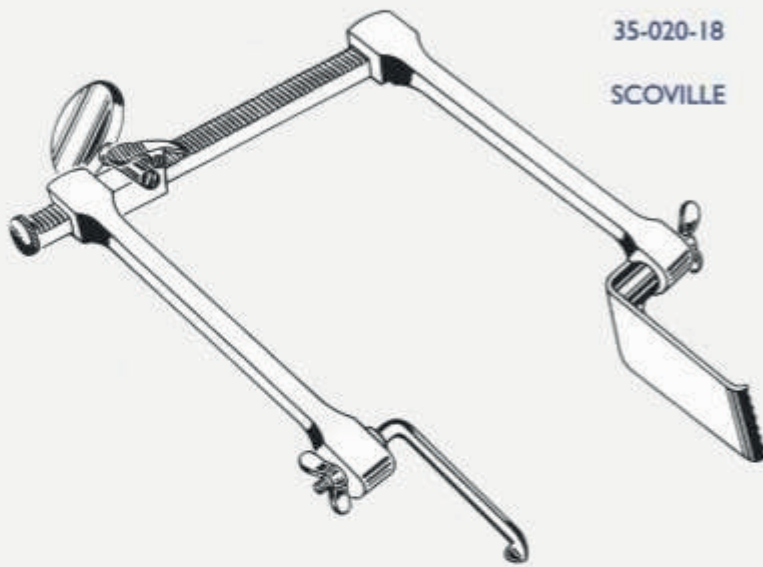

35-020-18

SCOVILLE



35-083-38

35-083-44



35-021-18

SCOVILLE  
HAVERFIELD

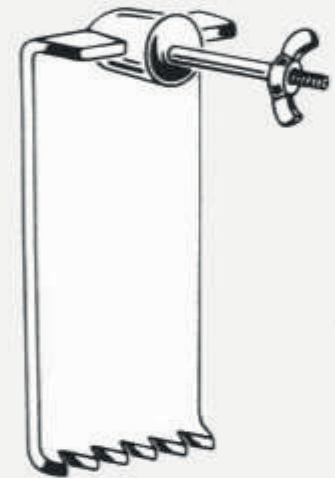

35-081-50

35-081-70

35-081-80



35-080-20

35-080-25

35-080-35

35-080-45

35-080-55

35-080-75



CASPAR  
LONGITUDINAL CERVICAL

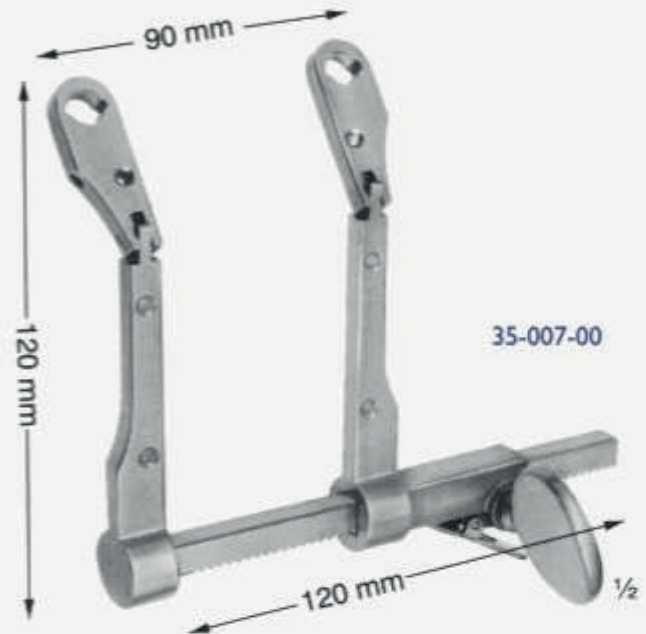

CASPAR  
TRANSVERSAL



45 mm - 35-077-45  
50 mm - 35-077-50  
55 mm - 35-077-55  
60 mm - 35-077-60  
65 mm - 35-077-65



45 mm - 35-078-45  
50 mm - 35-078-50  
55 mm - 35-078-55  
60 mm - 35-078-60  
65 mm - 35-078-65



45 mm - 35-075-45  
50 mm - 35-075-50  
55 mm - 35-075-55  
60 mm - 35-075-60  
65 mm - 35-075-65



45 mm - 35-076-45  
50 mm - 35-076-50  
55 mm - 35-076-55  
60 mm - 35-076-60  
65 mm - 35-076-65





SCOVILLE  
RETO



08 mm - 35-019-08  
13 mm - 35-019-13



SCOVILLE  
ANGULADO

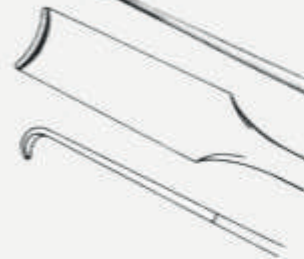

08 mm - 35-017-08  
13 mm - 35-017-13



BABY-INGE

16 CM  
00-000-00

AGUDO  
14 CM - 14-570-14  
18 CM - 14-570-18  
21 CM - 14-570-21

ROMBO  
14 CM - 14-571-14  
18 CM - 14-571-18  
21 CM - 14-571-21

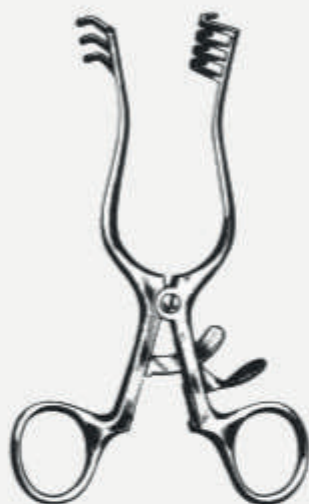

WEITLANER



TAYLOR

075 X 30 mm - 20-306-75  
100 X 30 mm - 20-306-10



ADSON

3.0 mm - 16-030-30  
3.5 mm - 16-030-35  
4.0 mm - 16-030-40



FRAZIER

1.0 mm - 16-061-10  
1.5 mm - 16-061-15  
2.0 mm - 16-061-20  
2.5 mm - 16-061-25  
3.0 mm - 16-061-30  
3.5 mm - 16-061-35  
4.0 mm - 16-061-40  
4.5 mm - 16-061-45  
5.0 mm - 16-061-50



FRAZIER C/PONTA PROTEGIDA  
E CONTROLE DE FLUXO

1.0 mm - 16-067-10  
1.5 mm - 16-067-15  
2.0 mm - 16-067-20  
2.5 mm - 16-067-25  
3.0 mm - 16-067-30  
3.5 mm - 16-067-35  
4.0 mm - 16-067-40  
4.5 mm - 16-067-45  
5.0 mm - 16-067-50

Nº 3 - 35-029-03  
Nº 4 - 35-029-04



CABO DE BISTURI  
EM BAIONETA



SERRA DE GIGLI

30 CM - 35-300-30  
40 CM - 35-300-40  
50 CM - 35-300-50

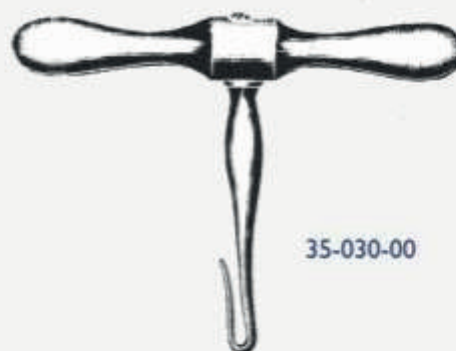

35-030-00

CABO P/SERRA DE  
GIGLI



35-048-01

MARTELL  
SIMPLES



35-048-02

MARTELL  
DUPLO



CLOWARD



10 mm - 35-036-10  
12 mm - 35-036-12  
14 mm - 35-036-14  
16 mm - 35-036-16  
18 mm - 35-036-18  
20 mm - 35-036-20  
22 mm - 35-036-22  
24 mm - 35-036-24





LAMBOTTE  
RETO

23 CM  
06 mm - 20-331-06  
10 mm - 20-331-10  
15 mm - 20-331-15  
20 mm - 20-331-20  
25 mm - 20-331-25  
30 mm - 20-331-30



LAMBOTTE  
CURVO

23 CM  
06 mm - 20-330-06  
10 mm - 20-330-10  
15 mm - 20-330-15  
20 mm - 20-330-20  
25 mm - 20-330-25  
30 mm - 20-330-30



ZAUFAL-JANSEN

18 CM  
5 X 15 mm - 20-473-18

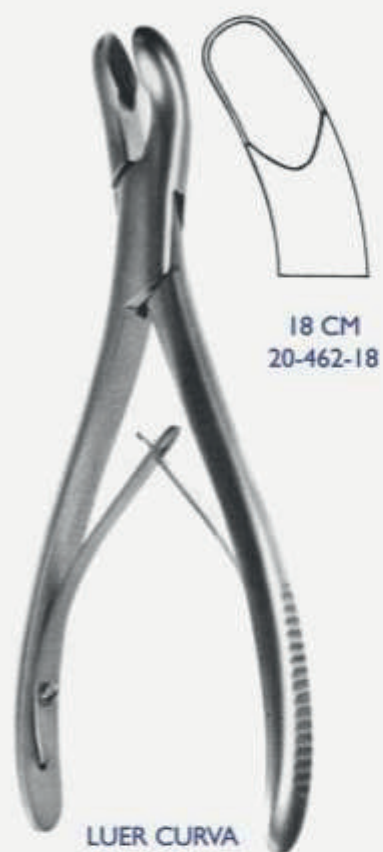
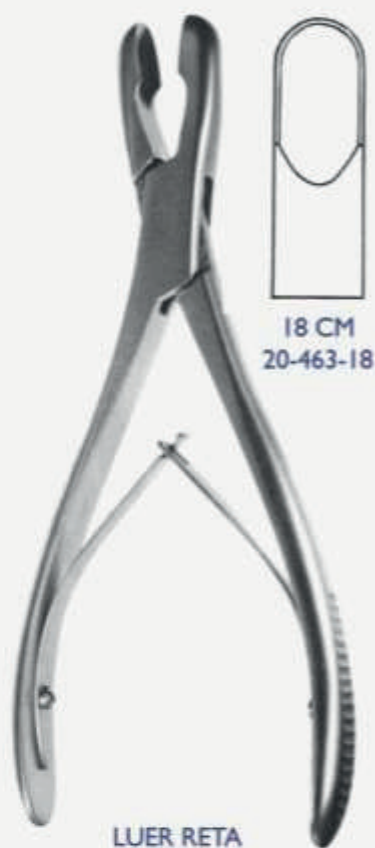

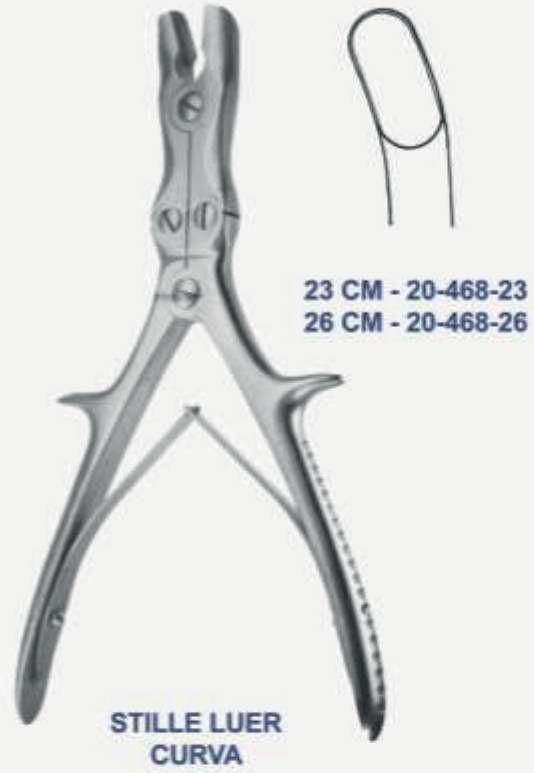



14 CM  
20-061-14  
19 CM  
20-061-19



14 CM  
20-060-14  
19 CM  
20-060-19



CIZALHA LISTON  
RETA

CIZALHA LISTON  
CURVA



27 CM  
35-039-27

LISTON KEY



18 CM  
20-073-18

RUSKIN RETA



18 CM  
20-072-18

RUSKIN CURVA





STILLE LISTON  
RETA



23 CM - 20-079-23  
27 CM - 20-079-27



STILLE LISTON  
CURVA



23 CM - 20-078-23  
27 CM - 20-078-27



HALLE  
MALEÁVEL

21 CM



Nº 1  
35-049-01



Nº 2  
35-049-01



Nº 3  
35-049-03



SIMON  
23 CM



SPRATT  
18 CM





15 CM  
35-052-15



FRAZIER

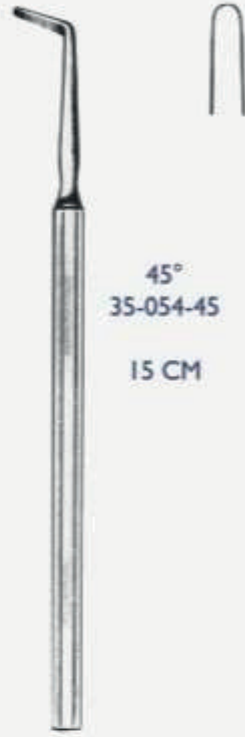

45°  
35-054-45  
15 CM

HOEN



90°  
35-054-90  
15 CM

HOEN

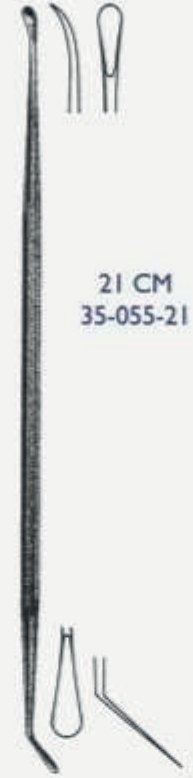

21 CM  
35-055-21

MILLIGAN



23 CM  
2 X 3 mm  
35-056-23

OLIVECRONA



25 CM  
4 X 5 mm  
35-056-25

OLIVECRONA



22 CM  
3 mm - 35-058-03  
6 mm - 35-058-06

SACHS



25 CM  
35-059-25

TOENNIS



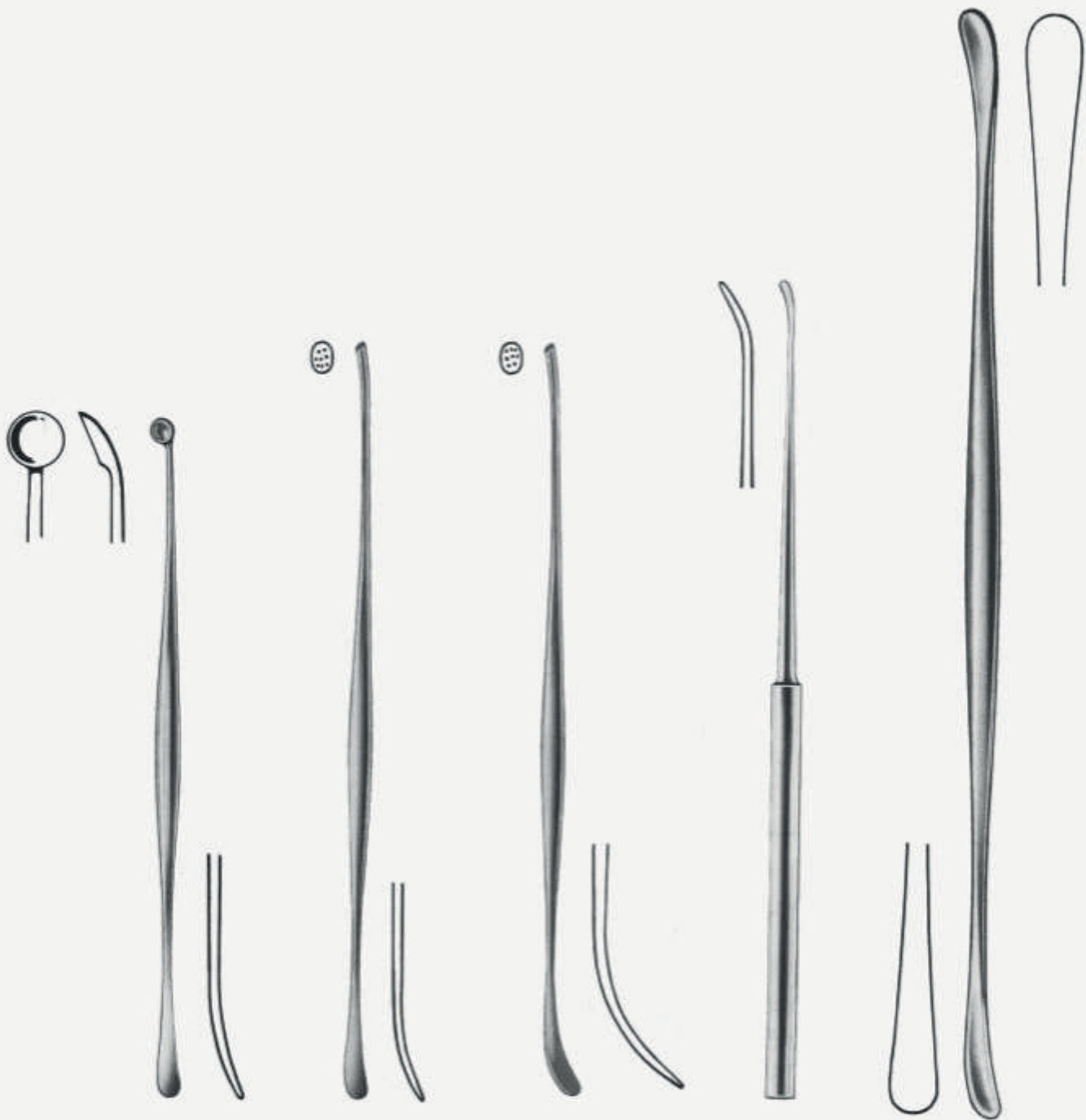

Nº 1  
35-057-01

PENFIELD

Nº 2  
35-057-02

PENFIELD

Nº 3  
35-057-03

PENFIELD

Nº 4  
35-057-04

PENFIELD

Nº 5  
35-057-05

PENFIELD

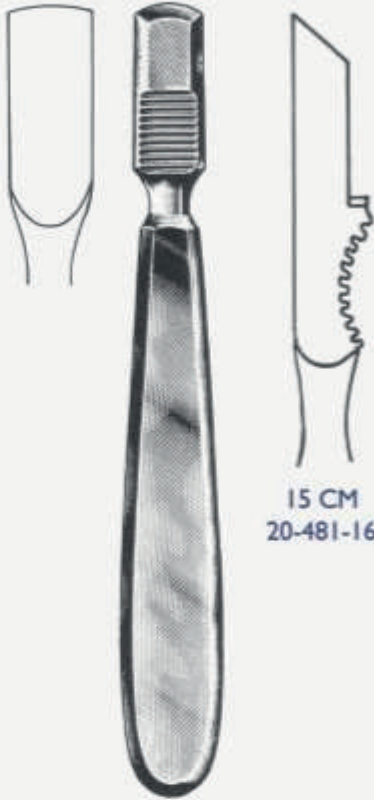

15 CM  
20-481-16

RUGINA  
FARABEUF RETA



15 CM  
20-480-16

RUGINA  
FARABEUF CURVA



6 mm - 51-540-06  
8 mm - 51-540-08

JOSEPH 16 CM



CUSHING



4 mm - 35-064-04  
5 mm - 35-064-05  
6 mm - 35-064-06  
7 mm - 35-064-07



HOEN



19 cm  
15 mm - 35-066-15  
20 mm - 35-066-20

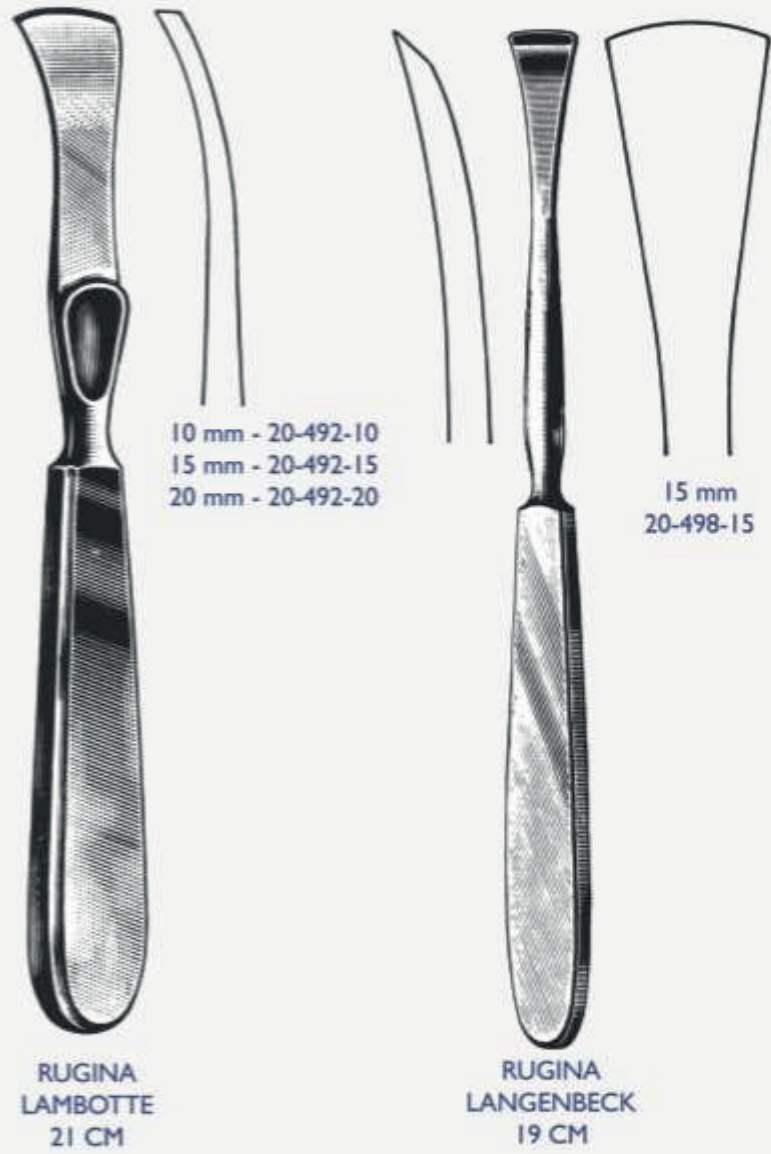

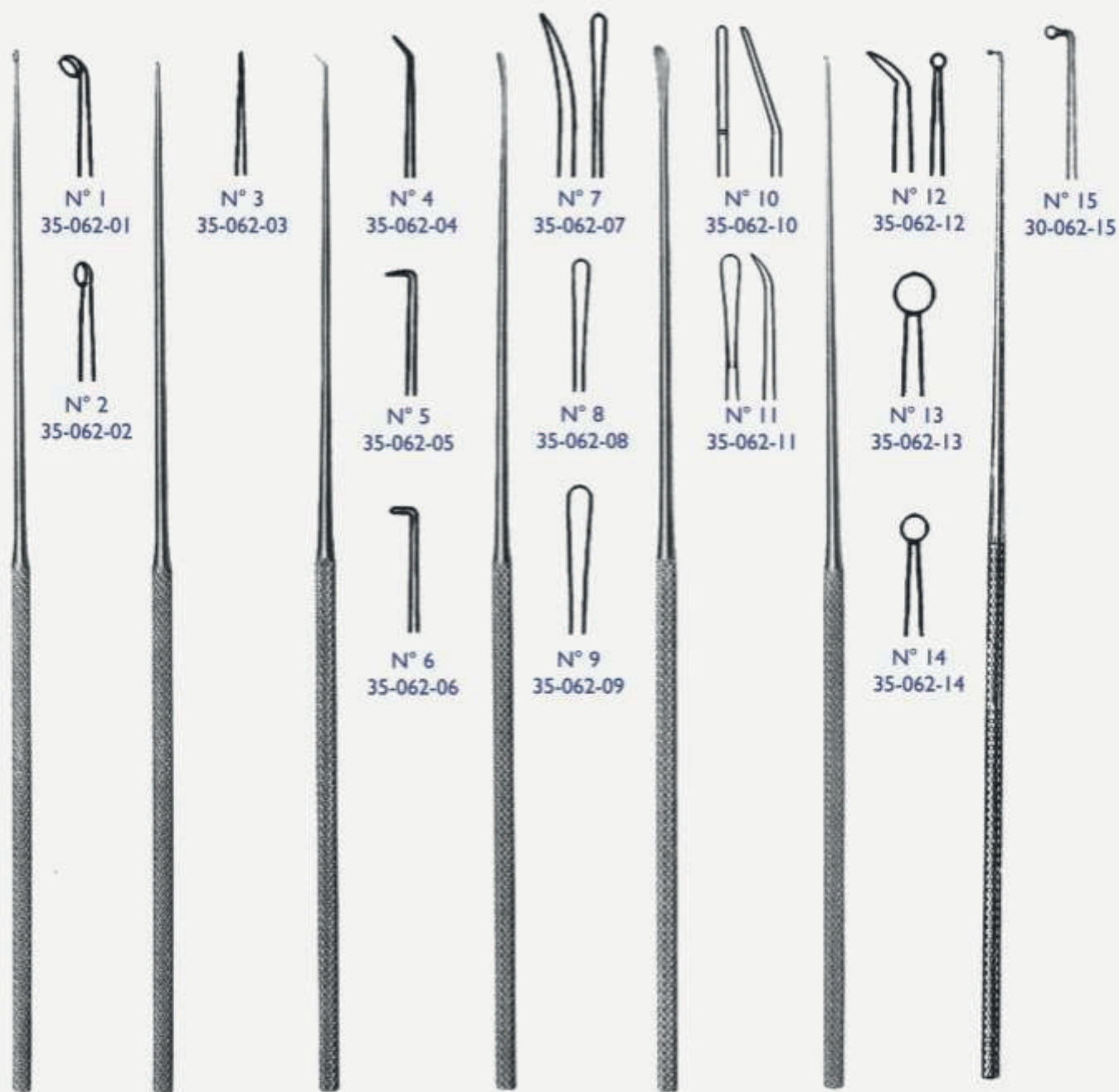

MICRO DISSECTORES RHOTON

JOGO COMPLETO 35-062-00







ESPÁTULA  
DAVIS

20 CM  
06 mm - 35-068-06  
08 mm - 35-068-08  
10 mm - 35-068-10  
12 mm - 35-068-12  
14 mm - 35-068-14  
16 mm - 35-068-16  
18 mm - 35-068-18  
20 mm - 35-068-20  
22 mm - 35-068-22  
24 mm - 35-068-24

JOGO COM 10  
35-068-00



ESPÉCULO  
HARDY  
90 mm - 35-070-90



ESPÉCULO  
NASAL  
KILLIAN

Nº 1 - 51-278-01  
Nº 2 - 51-278-02  
Nº 3 - 51-278-03  
Nº 4 - 51-278-04



GANCHO  
MALIS

19 CM  
2 mm - 35-084-02  
3 mm - 35-084-03

19 CM  
2 mm - 35-088-02  
3 mm - 35-088-03



14 CM  
35-110-14

PERFURADOR  
MANUAL



35-112-15

PINÇA ADSON  
P/ DURA



15 CM - 35-108-15  
18 CM - 35-108-18

PINÇA APLICADORA  
MC KENZIE



14 CM  
13-320-14

PINÇA  
DANDY



	TAMANHO	CÓDIGO
	3 mm	35-116-03
	5 mm	35-116-05

CLOWARD HARPER



	TAMANHO	CÓDIGO
	3 mm	35-115-03
	4 mm	35-115-04
	3 mm	35-114-03
	4 mm	35-114-04
	3 mm	35-113-03
	4 mm	35-113-04

CLOWARD



FERRIS SMITH  
KERRISON

90° PARA CIMA	
TAMANHO	CÓDIGO
1 mm	35-124-01
2 mm	35-124-02
3 mm	35-124-03
5 mm	35-124-05

40° PARA CIMA	
TAMANHO	CÓDIGO
1 mm	35-120-01
2 mm	35-120-02
3 mm	35-122-03
5 mm	35-120-05

90° PARA BAIXO	
TAMANHO	CÓDIGO
1 mm	35-125-01
2 mm	35-125-02
3 mm	35-125-03
5 mm	35-125-05





LOVE GRUENWALD

Ponta para Baixo.	
TAMANHO	CÓDIGO
2mm	35-136-02
3mm	35-136-03
4mm	35-136-04
Ponta para Cima	
TAMANHO	CÓDIGO
2mm	35-137-02
3mm	35-137-03
4mm	35-137-04
Ponta Reta	
TAMANHO	CÓDIGO
1mm	35-138-01
2mm	35-138-02
3mm	35-138-03
4mm	35-138-04



PINÇA P/ TUMOR  
HUNT



PINÇA  
JANSEN



PINÇA  
LUCAE



MARTEL



YASARGIL



YASARGIL



YASARGIL



TESOURA  
TAYLOR

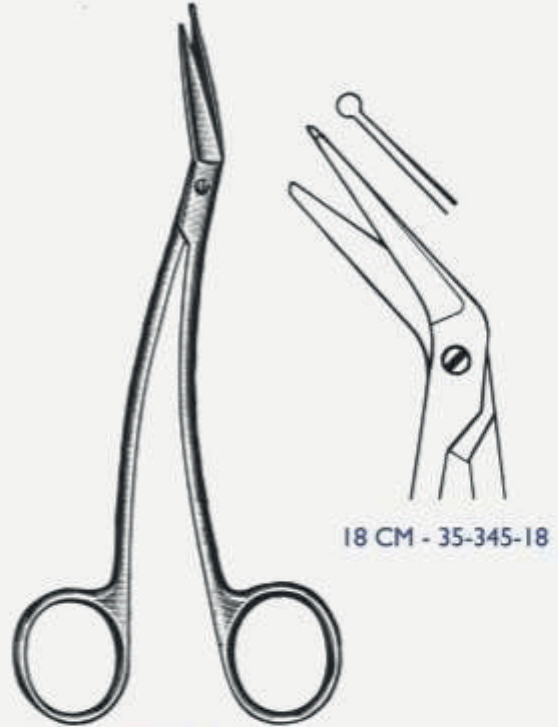

TESOURA  
FRAZIER



TESOURA  
OLIVECRONA



YASARGIL



35-380-00

HUDSON



PROLONGADOR  
DO HUDSON

35-106-85



CUSHING

09 mm - 35-089-09  
13 mm - 35-089-13



HUDSON

09 mm - 35-092-09



HUDSON

14 mm - 35-092-14





HUDSON

14 mm - 35-093-14  
16 mm - 35-093-16  
18 mm - 35-093-18  
20 mm - 35-093-20  
22 mm - 35-093-22



D'ERRICO

25 mm - 35-090-25  
35 mm - 35-090-35  
50 mm - 35-090-50



SMITH

35-094-00



TWIST DRILL

2,0 mm - 35-095-20  
2,5 mm - 35-095-25  
3,0 mm - 35-095-30